



Operator Manual

Generator Set

QSJ8.9G Engine with PowerCommand® 2.3 Control

C125 N6 (Spec B)

C150 N6 (Spec B)

**CALIFORNIA
Proposition 65**

Warning: Natural Gas/Liquid Propane Gas engine exhaust and some of its constituents are known to the State of California to cause cancer, birth defects, and other reproductive harm.

Table of Contents

1. IMPORTANT SAFETY INSTRUCTIONS	1
1.1 Warning, Caution, and Note Styles Used in This Manual	1
1.2 General Information	1
1.3 Generator Set Safety Code	4
1.4 Moving Parts Can Cause Severe Personal Injury or Death	4
1.5 Electrical Shocks and Arc Flashes Can Cause Severe Personal Injury or Death.....	5
1.6 Fuel and Fumes Are Flammable	5
1.7 Batteries Can Explode	6
1.8 Exhaust Gases Are Deadly.....	7
1.9 The Hazards of Carbon Monoxide.....	9
1.10 Earth Ground Connection	9
2. INTRODUCTION.....	11
2.1 Safety.....	11
2.2 About This Manual.....	11
2.3 Schedule of Abbreviations	12
2.4 Related Literature	14
2.5 Model Specifications	15
2.6 After Sales Services.....	19
3. CONTROL SYSTEM.....	25
3.1 Control System Description	25
3.2 Operator Panel.....	28
4. OPERATION - POWERCOMMAND 2.3	61
4.1 Safety Considerations.....	61
4.2 Introduction to Generator Set Operation.....	62
4.3 Maintenance	62
4.4 Operating Recommendations	62
4.5 Sequence of Operation	66
4.6 Before Starting	66
4.7 Stopping.....	72
4.8 Frequency Changing.....	73
5. MAINTENANCE	75
5.1 Maintenance Safety	75
5.2 Periodic Maintenance	78
5.3 Cooling System.....	85
5.4 Engine Oil	87
5.5 Air Intake System.....	93
5.6 Exhaust System Maintenance	97
5.7 Generator Set Output - AC Electric System Checks	98
5.8 DC Electrical System	99

5.9 Batteries.....	99
5.10 Spark Plugs	103
5.11 Cleaning the Generator Set Housing.....	103
5.12 Complete System Test	104
6. TROUBLESHOOTING	105
6.1 Avoiding Generator Set Shutdowns	105
6.2 Control System	105
6.3 Fault Finding	105
6.4 Fault Codes - PowerCommand 2.3	106
6.5 Line Circuit Breaker	112

1 IMPORTANT SAFETY INSTRUCTIONS

SAVE THESE INSTRUCTIONS. This manual contains important instructions that should be followed during installation and maintenance of the generator set and batteries.

Safe and efficient operation can be achieved only if the equipment is properly operated and maintained. Many accidents are caused by failure to follow fundamental rules and precautions.

1.1 Warning, Caution, and Note Styles Used in This Manual

The following safety styles and symbols found throughout this manual indicate potentially hazardous conditions to the operator, service personnel, or equipment.

DANGER

Indicates a hazardous situation that, if not avoided, will result in death or serious injury.

WARNING

Indicates a hazardous situation that, if not avoided, could result in death or serious injury.

CAUTION

Indicates a hazardous situation that, if not avoided, could result in minor or moderate injury.

NOTICE

Indicates information considered important, but not hazard-related (e.g., messages relating to property damage).

1.2 General Information

This manual should form part of the documentation package supplied by Cummins with specific generator sets. If this manual has been supplied in isolation, please contact your authorized dealer.

NOTICE

It is in the operator's interest to read and understand all warnings and cautions contained in the documentation relevant to the generator set operation and daily maintenance.

General Safety Precautions

WARNING

Hot Pressurized Liquid

Contact with hot liquid can cause severe burns.

Do not open the pressure cap while the engine is running. Let the engine cool down before removing the cap. Turn the cap slowly and do not open it fully until the pressure has been relieved.

WARNING

Moving Parts

Moving parts can cause severe personal injury.

Use extreme caution around moving parts. All guards must be properly fastened to prevent unintended contact.

WARNING

Toxic Hazard

Used engine oils have been identified by some state and federal agencies to cause cancer or reproductive toxicity.

Do not ingest, breathe the fumes, or contact used oil when checking or changing engine oil. Wear protective gloves and face guard.

WARNING

Electrical Generating Equipment

Incorrect operation and maintenance can result in severe personal injury or death.

Do not operate equipment when fatigued, or after consuming any alcohol or drug.

Make sure that only suitably trained and experienced service personnel perform electrical and/or mechanical service.

WARNING

Toxic Gases

Substances in exhaust gases have been identified by some state and federal agencies to cause cancer or reproductive toxicity.

Do not breathe in or come into contact with exhaust gases.

WARNING

High Noise Level

Generator sets in operation emit noise, which can cause hearing damage.

Wear appropriate ear protection at all times.

⚠ WARNING**Hot Surfaces**

Contact with hot surfaces can cause severe burns.

The unit is to be installed so that the risk of hot surface contact by people is minimized. Wear appropriate PPE when working on hot equipment and avoid contact with hot surfaces.

⚠ WARNING**Toxic Hazard**

Ethylene glycol, used as an engine coolant, is toxic to humans and animals.

Wear appropriate PPE. Clean up coolant spills and dispose of used coolant in accordance with local environmental regulations.

⚠ WARNING**Combustible Liquid**

Ignition of combustible liquids is a fire or explosion hazard which can cause severe burns or death.

Do not store fuel, cleaners, oil, etc., near the generator set. Do not use combustible liquids like ether.

⚠ WARNING**Combustible Gases**

Generator sets in operation have combustible gases under pressure, which if ignited can cause eye and ear damage.

Wear appropriate eye and ear protection at all times.

⚠ WARNING**Combustible Gases**

Generator sets in operation have combustible gases under pressure, which if ignited can cause severe injury.

Do not operate the generator set with any doors open.

⚠ WARNING**Fire Hazard**

Materials drawn into the generator set, as well as accumulated grease and oil, are a fire hazard. Fire can cause severe burns or death.

Keep the generator set and the surrounding area clean and free from obstructions. Make sure the generator set is mounted in a manner to prevent combustible materials from accumulating under the unit.

⚠ WARNING***Automated Machinery***

Accidental or remote starting of the generator set can cause severe personal injury or death.

Isolate all auxiliary supplies and use an insulated wrench to disconnect the starting battery cables (negative [-] first).

NOTICE

Keep multi-type ABC fire extinguishers close by. Class A fires involve ordinary combustible materials such as wood and cloth. Class B fires involve combustible and flammable liquid fuels and gaseous fuels. Class C fires involve live electrical equipment. (Refer to NFPA No. 10 in the applicable region.)

NOTICE

Before performing maintenance and service procedures on enclosed generator sets, make sure the service access doors are secured open.

NOTICE

Stepping on the generator set can cause parts to bend or break, leading to electrical shorts, or to fuel leaks, coolant leaks, or exhaust leaks. Do not step on the generator set when entering or leaving the generator set room.

1.3 Generator Set Safety Code

Before operating the generator set, read the manuals and become familiar with them and the equipment. **Safe and efficient operation can be achieved only if the equipment is properly operated and maintained.** Many accidents are caused by failure to follow fundamental rules and precautions.

⚠ WARNING***Electrical Generating Equipment***

Incorrect operation and maintenance can result in severe personal injury or death.

Read and follow all Safety Precautions, Warnings, and Cautions throughout this manual and the documentation supplied with the generator set.

1.4 Moving Parts Can Cause Severe Personal Injury or Death

- Keep hands, clothing, and jewelry away from moving parts.

- Before starting work on the generator set, disconnect the battery charger from its AC source, then disconnect the starting batteries using an insulated wrench, negative (–) cable first. This will prevent accidental starting.
- Make sure that fasteners on the generator set are secure. Tighten supports and clamps; keep guards in position over fans, drive belts, etc.
- Do not wear loose clothing or jewelry in the vicinity of moving parts or while working on electrical equipment. Loose clothing and jewelry can become caught in moving parts.
- If any adjustments must be made while the unit is running, use extreme caution around hot manifolds, moving parts, etc.

1.5 Electrical Shocks and Arc Flashes Can Cause Severe Personal Injury or Death

- Only qualified service personnel certified and authorized to work on power circuits should work on exposed energized power circuits.
- All relevant service material must be available for any electrical work performed by certified service personnel.
- Exposure to energized power circuits with potentials of 50 VAC or 75 VDC or higher poses a significant risk of electrical shock and electrical arc flash.
- Refer to standard NFPA 70E, or equivalent safety standards in corresponding regions, for details of the dangers involved and for safety requirements.

1.6 Fuel and Fumes Are Flammable

Fire, explosion, and personal injury or death can result from improper practices.

- Do not fill fuel tanks while the engine is running unless the tanks are outside the engine compartment. Fuel contact with hot engine or exhaust is a potential fire hazard.
- Do not permit any flame, cigarette, pilot light, spark, arcing equipment, or other ignition source near the generator set or fuel tank.
- Fuel lines must be adequately secured and free of leaks. Fuel connection at the engine should be made with an approved flexible line. Do not use copper piping on flexible lines as copper will become brittle if continuously vibrated or repeatedly bent.
- Make sure all fuel supplies have a positive shutoff valve.
- Make sure the battery area has been well-ventilated prior to servicing near it. Lead-acid batteries emit a highly explosive hydrogen gas that can be ignited by arcing, sparking, smoking, etc.

Do Not Operate in Flammable and Explosive Environments

Flammable vapor can cause an engine to over speed and become difficult to stop, resulting in possible fire, explosion, severe personal injury, and death. Do not operate a generator set where a flammable vapor environment can be created, unless the generator set is equipped with an automatic safety device to block the air intake and stop the engine. The owners and operators of the generator set are solely responsible for operating the generator set safely. Contact your authorized Cummins distributor for more information.

Spillage

Any spillage that occurs during fueling, oil top-off, or oil change must be cleaned up before starting the generator set.

Fluid Containment

NOTICE

Where spillage containment is not part of a Cummins supply, it is the responsibility of the installer to provide the necessary containment to prevent contamination of the environment, especially water courses and sources.

If fluid containment is incorporated into the bedframe, it must be inspected at regular intervals. Any liquid present should be drained out and disposed of in line with local health and safety regulations. Failure to perform this action may result in spillage of liquids which could contaminate the surrounding area.

Any other fluid containment area must also be checked and emptied, as described above.

1.7 Batteries Can Explode

Batteries can explode, causing severe skin and eye burns and can release toxic electrolytes.

WARNING

Combustible Gases

Batteries can explode, causing severe skin and eye burns, and can release toxic electrolytes.

Do not dispose of the battery in a fire, because it is capable of exploding. Do not open or mutilate the battery. Do not charge frozen batteries.

⚠ WARNING***Electric Shock Hazard******Batteries present the risk of high short circuit current.******When servicing the generator set:***

- ***Remove watches, rings, or other metal objects.***
- ***Use tools with insulated handles.***

NOTICE**Service of batteries must be performed or supervised by personnel knowledgeable of batteries and the required precautions. Keep unauthorized personnel away from batteries.**

- Wear safety glasses.
- Do not smoke.
- Do not charge frozen batteries.
- To prevent arcing when disconnecting the battery:
 1. Press the Off switch from the display and then press the E-Stop button (if equipped).
 2. Disconnect AC power from any battery chargers.
 3. Remove the negative (-) battery cables to prevent starting.
- To prevent arcing when reconnecting the battery:
 1. Reconnect the positive (+) cables.
 2. Reconnect the negative (-) cables.
 3. Reconnect the battery charger to AC power supply.
- When replacing the generator set battery, always replace it with a battery as specified in this manual.

1.8 Exhaust Gases Are Deadly

- Provide an adequate exhaust system to properly expel discharged gases away from enclosed or sheltered areas, and areas where individuals are likely to congregate. Visually and audibly inspect the exhaust system daily for leaks per the maintenance schedule. Make sure that exhaust manifolds are secured and not warped. Do not use exhaust gases to heat a compartment.
- Make sure the unit is well ventilated.

Exhaust Precautions

WARNING

Hot Exhaust Gases

Contact with hot exhaust gases can cause severe burns.

Wear personal protective equipment when working on equipment.

WARNING

Hot Surfaces

Contact with hot surfaces can cause severe burns.

The unit is to be installed so that the risk of hot surface contact by people is minimized. Wear appropriate PPE when working on hot equipment and avoid contact with hot surfaces.

WARNING

Toxic Gases

Inhalation of exhaust gases can cause asphyxiation and death.

Pipe exhaust gas outside and away from windows, doors, or other inlets to buildings. Do not allow exhaust gas to accumulate in habitable areas.

WARNING

Fire Hazard

Contaminated insulation is a fire hazard. Fire can cause severe burns or death.

Remove any contaminated insulation and dispose of it in accordance with local regulations.

The exhaust outlet may be sited at the top or bottom of the generator set. Make sure that the exhaust outlet is not obstructed. Personnel using this equipment must be made aware of the exhaust position. Position the exhaust away from flammable materials - in the case of exhaust outlets at the bottom, make sure that vegetation is removed from the vicinity of the exhaust.

The exhaust pipes may have some insulating covers fitted. If these covers become contaminated they must be replaced before the generator set is run.

To minimize the risk of fire, make sure the following steps are observed:

- Make sure that the engine is allowed to cool thoroughly before performing maintenance or operation tasks.
- Clean the exhaust pipe thoroughly.

1.9 The Hazards of Carbon Monoxide

Carbon monoxide (CO) is an odorless, colorless, tasteless and non-irritating gas. You cannot see it or smell it. Red blood cells, however, have a greater affinity for CO than for oxygen. Therefore, exposure even to low levels of CO for a prolonged period can lead to asphyxiation (lack of oxygen) resulting in death. Mild effects of CO poisoning include eye irritation, dizziness, headaches, fatigue and the inability to think clearly. More extreme symptoms include vomiting, seizures and collapse.

Engine-driven generator sets produce harmful levels of carbon monoxide that can injure or kill you.

Special Risks of CO near the Home

WARNING

Toxic Gases

Carbon monoxide (CO) gas can cause nausea, fainting, or death. Residents can be exposed to lethal levels of CO when the generator set is running. Depending on air temperature and wind, CO can accumulate in or near the home.

To protect yourself and others from the dangers of CO poisoning, it is recommended that reliable, approved, and operable CO detector alarms are installed in proper locations in the home as specified by their manufacturer.

Protecting Yourself from CO Poisoning

- Locate the generator set in an area where there are no windows, doors, or other access points into the home.
- Make sure all CO detectors are installed and working properly.
- Pay attention for signs of CO poisoning.
- Check the exhaust system for corrosion, obstruction, and leaks every time you start the generator set and every eight hours when you run it continuously.

1.10 Earth Ground Connection

The neutral of the generator set may be required to be bonded to earth ground at the generator set location, or at a remote location, depending on system design requirements. Consult the engineering drawings for the facility or a qualified electrical design engineer for proper installation.

NOTICE

The end user is responsible to make sure that the ground connection point surface area is clean and free of rust before making a connection.

NOTICE

The end user is responsible for making sure that an earthing arrangement that is compliant with local conditions is established and tested before the equipment is used.

2 Introduction

2.1 Safety

 **WARNING**

Hazardous Voltage

Contact with high voltages can cause severe electrical shock, burns, or death.

Make sure that only a trained and experienced electrician makes generator set electrical output connections, in accordance with the installation instructions and all applicable codes.

 **WARNING**

Electrical Generating Equipment

Faulty electrical generating equipment can cause severe personal injury or death.

Generator sets must be installed, certified, and operated by trained and experienced persons in accordance with the installation instructions and all applicable codes.

2.2 About This Manual

The purpose of this manual is to provide the users with sound, general information. It is for guidance and assistance with recommendations for correct and safe procedures. Cummins Inc. cannot accept any liability whatsoever for problems arising as a result of following recommendations in this manual.

The information contained within the manual is based on information available at the time of going to print. In line with Cummins Inc. policy of continuous development and improvement, information may change at any time without notice. The users should therefore make sure that they have the latest information available before starting any work. The latest version of this manual is available on QuickServe Online (<https://quickserve.cummins.com>).

Users are respectfully advised that, in the interests of good practice and safety, it is their responsibility to employ competent people to carry out any installation work. Consult your authorized dealer for further installation information. It is essential that the utmost care is taken with the application, installation, and operation of any generator set due to their potentially hazardous nature. Careful reference should also be made to other Cummins Inc. literature. You must operate and maintain your generator set properly if you are to expect safe and reliable operation.

For further assistance, contact your authorized Cummins Inc. dealer.

NOTICE

This device complies with part 15 of the FCC rules. Operation is subject to the following two conditions:

- This device may not cause harmful interferences.
- This device must accept any interference received, including interference that may cause undesired operation.

2.3 Schedule of Abbreviations

This list is not exhaustive. For example, it does not identify units of measure or acronyms that appear only in parameters, event/fault names, or part/accessory names.

Abbr.	Description	Abbr.	Description
AC	Alternating Current	LED	Light-Emitting Diode
AMP	AMP, Inc. (part of Tyco Electronics)	MFM	Multifunction Monitor
ANSI	American National Standards Institute	Mil Std	Military Standard
ASOV	Automatic Shut Off Valve	MPU	Magnetic Pickup
ASTM	American Society for Testing and Materials (ASTM International)	NC	Normally Closed
ATS	Automatic Transfer Switch	NC	Not Connected
AVR	Automatic Voltage Regulator	NFPA	National Fire Protection Agency
AWG	American Wire Gauge	NO	Normally Open
CAN	Controlled Area Network	NWF	Network Failure
CB	Circuit Breaker	OEM	Original Equipment Manufacturer
CE	Conformité Européenne	OOR	Out Of Range
CCA	Cold Cranking Ampere	OORH/ ORH	Out Of Range High
CFM	Cubic Feet per Minute	OORL/ORL	Out Of Range Low
CGT	Cummins Generator Technologies	PB	Push Button
CMM	Cubic Meters per Minute	PCC	PowerCommand® Control

Abbr.	Description	Abbr.	Description
CT	Current Transformer	PGI	Power Generation Interface
DC	Direct Current	PGN	Parameter Group Number
DEF	Diesel Exhaust Fluid	PI	Proportional/Integral
DPF	Diesel Particulate Filter	PID	Proportional/Integral/ Derivative
EBS	Excitation Boost System	PLC	Programmable Logic Controller
ECM	Engine Control Module	PMG	Permanent Magnet Generator
ECS	Engine Control System	PPE	Personal Protective Equipment
EMI	Electromagnetic Interference	PT	Potential Transformer
EN	European Standard	PTC	Power Transfer Control
EPS	Engine Protection System	PWM	Pulse-Width Modulation
E-Stop	Emergency Stop	RFI	Radio Frequency Interference
FAE	Full Authority Electronic	RH	Relative Humidity
FMI	Failure Mode Identifier	RMS	Remote Monitoring System
FSO	Fuel Shutoff	RMS	Root Mean Square
Genset	Generator Set	RTU	Remote Terminal Unit
GCP	Generator Control Panel	SAE	Society of Automotive Engineers
GND	Ground	scfh	Standard Cubic Feet of gas per Hour
HMI	Human-Machine Interface	SCR	Selective Catalytic Reduction
IC	Integrated Circuit	SPN	Suspect Parameter Number
ISO	International Organization for Standardization	SW_B+	Switched B+
LBNG	Lean-Burn Natural Gas	UL	Underwriters Laboratories

Abbr.	Description	Abbr.	Description
LCD	Liquid Crystal Display	UPS	Uninterruptible Power Supply
LCT	Low Coolant Temperature		

2.4 Related Literature

Before any attempt is made to operate the generator set, the operator should take time to read all of the manuals supplied with the generator set and familiarize themselves with the warnings and operating procedures.

A generator set must be operated and maintained properly if you are to expect safe and reliable operation. The Operator manual includes a maintenance schedule and a troubleshooting guide. The Health and Safety manual must be read in conjunction with the Operator manual for the safe operation of the generator set.

The following documents are shipped with the generator set:

- Installation Manual for QSJ8.9G Engine with PowerCommand 2.3/3.3 Control (A062T541)
- Operator Manual for QSJ8.9G Engine with PowerCommand 2.3 Control (A062T543)
- Health and Safety Manual (0908-0110-00)
- Global Commercial Warranty Statement (A040H442)
- Emission Warranty Statement (Federal Emissions EPA Title 40 CFR Part 1048 Component Warranty) (A028X279)

The relevant manuals appropriate to your generator set are also available; the documents below are in English:

- Generator Set Service Manual for QSJ8.9G Engine with PowerCommand 2.3 Control (A062T546)
- Controller Service Manual for PowerCommand 2.3 Controller (0900-0666)
- Recommended Spares List (RSL) for each model:
 - C125 N6 (A057P648)
 - C150 N6 (A057P650)
- Parts Manual for QSJ8.9G Engine with PowerCommand 2.3 and 3.3 Control (A056K402)
- Universal Annunciator Owner Manual (0900-0301)
- Standard Repair Times - IB Family (A057P652)
- Service Tool Manual (A043D529)
- Failure Code Manual (F1115C)

- Engineering Application Manual T-030: Liquid Cooled Generator Sets (A040S369)

2.5 Model Specifications

NOTICE

Damage caused by failure to follow the manufacturer's recommendation will not be covered by the warranty. Please contact your authorized distributor.

TABLE 1. 8.9L MODEL VARIATIONS

Models	Description
C125 N6, C150 N6	60 Hz, 1800 RPM

TABLE 2. COLD WEATHER SPECIFICATIONS (ALL MODELS)

Temperature	Description of Components	Battery Quantity	Group
Above 4 °C (40 °F)	Battery charger, oil heater	1	34
-17 - 4 °C (0 to 40 °F)	Battery charger, coolant heater (1500 W), CCV heater*, oil heater	1	34
Below -17 °C (0 °F)	Battery charger, coolant heater (2000 W), battery heater, CCV heater*, oil heater	2	34

*CCV heaters are provided as part of the cold and extreme cold coolant heater packages.

NOTICE

For NFPA 110 applications, a coolant heater is required. A factory option is available.

TABLE 3. FUEL SPECIFICATIONS 60 HZ, 1800 RPM

Type	Unit	C125 N6	C150 N6
Natural Gas Full Load	scfh	1665.6	1915.3
	BTU/hr	1,590,182	1,828,620
Liquid Propane Full Load	scfh	674.1	783.0
	BTU/hr	1,598,738	1,857,009
Fuel Pressure	1.5 - 3.2 kPa (6 to 13 inches of water column) under any condition		

TABLE 4. ENGINE SPECIFICATIONS (ALL MODELS)

Type	Specification
Engine	6 cylinder in-line, single-cam, liquid-cooled, 4-stroke, spark ignited
Bore	114 mm (4.49 in)
Stroke	145 mm (5.69 in)
Displacement	8.9 L (543.1 in ³)
Compression Ratio	8.5:1
Firing Order	1-5-3-6-2-4
Spark Plug Gap	0.40 mm (.016 in)
Spark Plug Torque	38 Nm (28 ft-lb)
Crankshaft Rotation (Viewed from the Front of the Engine)	Clockwise
Engine Weight (Dry, Long Block Only)	693 kg (1527.8 lb)
Valve Clearance (Intake)	0.355 mm (0.014 in)
Valve Clearance (Exhaust)	0.6604 mm (0.026 in)
Coolant	<ul style="list-style-type: none"> • 50/50 coolant solution (50% pure water and 50% anti-freeze) • 11 L (2.9 gal) capacity
Oil Capacity	22 L (5.81 gal)
Oil Standards	<ul style="list-style-type: none"> • Must adhere to Cummins® Engineering Standard (CES) 20074 • Use of improper oils can result in engine damage. Use only the required oils: <ul style="list-style-type: none"> ◦ 5W-40 (all ambient temperatures) ◦ 15W-40 (above 4 °C [40 °F] ambient temperature) (use of GEO 15W-40 oil in ambient temperatures below 4 °C (40 °F) could result in engine turbocharger damage) • A sulfated ash limit of 0.6% mass has been placed on all engine lubricating oils recommended for use in Cummins® B, natural gas engines. Higher ash oils can cause valve and/or piston damage, cause spark plug fouling, and lead to excessive oil consumption and degradation of the catalyst.

TABLE 5. LUBRICATING OIL SYSTEM SPECIFICATIONS

Type	Specification
Lubricating Oil Pressure at Idle (Minimum)	69 kPa (10 psi)
Lubricating Oil Pressure at Rated Speed (Minimum)	138 kPa (20 psi)
Filter Bypass Valve-Opening Pressure	345 kPa (50 psi)
Pressure Regulator Valve-Opening Pressure	417 kPa (60 psi)
Lubricating Oil Capacity (Standard Sump):	
--High	19 L (20 qt)
--Low	15 L (16 qt)
--Total System	20.8 L (22 qt)

TABLE 6. GENERATOR SET SIZE SPECIFICATIONS

Enclosure Type	Size (L x W x H)
Open/Weather	2867 x 1016 x 1666 mm (113 x 40 x 65.6 in); does not include exhaust discharge elbow
Sound Level 1	3621 x 1016 x 1666 mm (143 x 40 x 65.6 in)
Sound Level 2	4061 x 1016 x 1666 mm (160 x 40 x 65.6 in)

TABLE 7. GENERATOR SET WET WEIGHT (ALL MODELS) (60 HZ, 1800 RPM)

Configuration	lbs	kg
Open	3475	1576
Weather	3801	1724
Sound Level 1	3907	1772
Sound Level 2	3940	1787

NOTICE

Weights are approximate and can be affected by selected options. Refer to outline drawings for specific weight information.

TABLE 8. ALTERNATOR SPECIFICATIONS 60 HZ, 1800 RPM

Type	C125 N6	C150 N6
Generator	Brushless, 4-pole rotating field, single bearing	
Power (kVA) 1 Phase	125	150
Power (kVA) 3 Phase	156.25	187.5
Rated Voltages (V)	120/240, 1 Ph (Reconnectable)	
	227/480, 3 Ph WYE	
	347/600, 3 Ph WYE	
	120/240, 3 Ph DELTA	
	120/208, 3 Ph WYE	
	127/220, 3 Ph WYE	

NOTICE

Maximum $I_2 = 8\%$. Generator set load unbalance must not exceed 25% between any phases.

TABLE 9. GENERATOR SET DERATING GUIDELINES

Model	Phase	Engine Power Available Up To...		Derate At...	
		Elevation	Ambient Temperature	Elevation	Temperature
C125 N6	1 & 3	1800 m (5900 ft)	40 °C (104 °F)	4.25% per 300 m (985 ft)	2% per 10 °C (18 °F)
C150 N6	1 & 3	775 m (2540 ft)			

TABLE 10. CONTROL SPECIFICATIONS (ALL MODELS)

Control	Purpose
PowerCommand 2.3	Generator Set
PowerCommand 3.3	Generator Set
Enovation 4G LDI	Engine (125, 150 kW Generator Sets)

TABLE 11. DC SYSTEM SPECIFICATIONS (ALL MODELS)

Type	Specification
Nominal Battery Voltage	12 VDC
Battery Group	34 (1 standard; 2 optional)
Battery Type	Lead acid, maintenance-free
Minimum Cold Crank Amps	850 standard, 1080 high capacity

TABLE 12. FUSE SPECIFICATIONS

Fuse	Amps	Volts	Comment
F1	20	32	1/4" x 1 1/4" cylindrical glass cartridge, fast acting
F2	10		
F3	20		
F4	5		
F5	20		
F6	10		
F7	10	600	Class G size-rejecting, current limiting
F8	10		

2.6 After Sales Services

Cummins offers a full range of maintenance and warranty services.

Maintenance

⚠ WARNING

Electrical Generating Equipment

Incorrect service or parts replacement can result in severe personal injury, death, and/or equipment damage.

Make sure service personnel are qualified to perform electrical and mechanical service.

For expert generator set service at regular intervals, contact your Cummins service provider. See power.cummins.com/sales-service-locator for service locations that service this application. Maintenance tasks should only be undertaken by trained and experienced technicians provided by your Cummins service provider.

Warranty

For details of the warranty coverage for your generator set, refer to the *Warranty Statement* listed in the Related Literature section.

Extended warranty coverage is also available. In the event of a breakdown, prompt assistance can normally be given by factory trained service technicians with facilities to undertake all minor and many major repairs to equipment on site.

For further warranty details, contact your authorized dealer.

NOTICE

Damage caused by failure to follow the manufacturer's recommendations will not be covered by the warranty. Please contact your authorized dealer.

Warranty Limitations

For details of the warranty limitations for your generator set, refer to the warranty statement applicable to the generator set.

How to Obtain Service

For parts, service, and product information, contact the nearest authorized Cummins dealer. To easily locate the nearest certified distributor/dealer for Cummins generator sets in your area, or for more information, contact us at 1-800-CUMMINS™ (1-800-286-6467) or visit www.cummins.com/support.

Generator Set Nameplate

⚠ WARNING

Electrical Generating Equipment

Improper service or replacement of parts can lead to severe personal injury or death and to damage to equipment and property.

Make sure service personnel are qualified to perform electrical and mechanical service.

NOTICE

Unauthorized modifications or replacement of fuel, exhaust, air intake or speed control system components that affect engine emissions are prohibited by law in the State of California.

Model, Spec, and Serial Numbers: Be ready to provide the model, spec, and serial numbers on the generator set nameplate when contacting Cummins for information, parts, and service. The nameplate is located on the inside of the customer access door on enclosed generator sets.

Record these numbers so that they are easy to find when needed. Each character in these numbers is significant for obtaining the right parts listed in the Parts Catalog. Genuine Cummins replacement parts are recommended for best results.

My Generator Set Information	
Model	
Spec	
Serial Number	

Manufacturing Facilities

Facility	Address	Phone Numbers
U.S. and CANADA	Cummins Inc. 1400 73rd Ave. NE Minneapolis, MN 55432 USA	Toll Free 1-800-CUMMINS™ (1-800-286-6467) Phone +1 763-574-5000 Fax +1 763-574-5298
EMEA, CIS	Cummins Inc. Columbus Avenue Manston Park Manston, Ramsgate Kent CT12 5BF United Kingdom ----- Cummins Inc. Royal Oak Way South Daventry Northamptonshire NN11 8NU United Kingdom	Phone +44 1843 255000 Fax +44 1843 255902
ASIA PACIFIC	Cummins Inc. 10 Toh Guan Road #07-01 TT International Tradepark Singapore 608838	Phone +65 6417 2388 Fax +65 6417 2399
BRAZIL	Rua Jati, 310, Cumbica Guarulhos, SP 07180-900 Brazil	Phone +55 11 2186 4195 Fax +55 11 2186 4729
CHINA	Cummins Inc. 2 Rongchang East Street, Beijing Economic – Technological Development Area Beijing 100176, P.R. China	Phone 86 10 59023001 Fax +86 10 5902 3199
INDIA	Cummins Inc. Plot No B-2, SEZ Industrial Area, Village-Nandal & Surwadi, Taluka- Phaltan Dist- Satara, Maharashtra 415523 India	Phone +91 021 66305514
LATIN AMERICA	3350 Southwest 148th Ave. Suite 205 Miramar, FL 33027 USA	Phone +1 954 431 551 Fax +1 954 433 5797

Facility	Address	Phone Numbers
MEXICO	Eje 122 No. 200 Zona Industrial San Luis Potosi, S.L.P. 78395 Mexico	Phone +52 444 870 6700 Fax +52 444 824 0082

This page is intentionally blank.

3 Control System

3.1 Control System Description

The control system is used to start and stop the generator set from the display screen in either Manual or Auto mode. It is suitable for standalone or paralleling generator sets in both standby and prime-power applications, providing full generator set monitoring capability and protection. It monitors the engine for temperature, oil pressure and speed, and provides voltage and current metering. In the event of a fault the unit indicates the fault type and automatically shuts down the generator set on critical faults.

All indicators, control buttons and the display screen are on the face of the operator panel as illustrated in the following figure.

There are two fault level signals generated by the control system as follows:

- **Warning:** signals an imminent or non-critical fault for the engine. The control provides an indication only for this condition.
- **Shutdown:** signals a potentially critical fault for the engine. The control immediately takes the engine off-load and automatically shuts it down.

The standard control system operates on 12 VDC or 24 VDC battery power. The auxiliary equipment operates on LV AC power. The history data is stored in non-volatile memory and is not deleted if battery power is lost.

Control System Panel

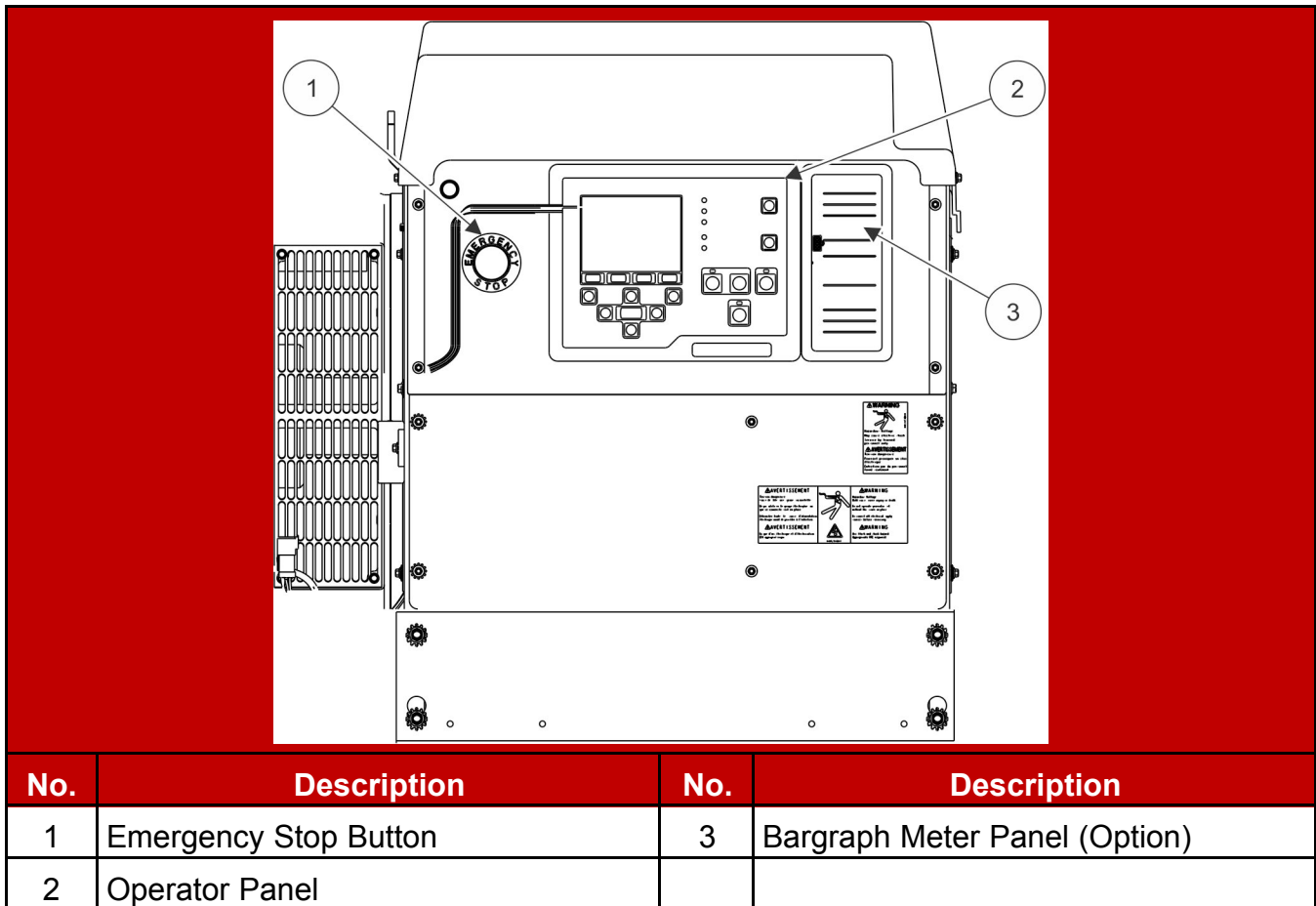

FIGURE 1. CONTROL SYSTEM PANEL

Operating Modes

The PowerCommand® 2.3 control is operated by the Start/Stop/Manual/Auto buttons on the operator panel. Refer to the Operator Panel section to view these buttons.

NOTICE

If the Mode Change access feature is enabled, a password is required to use these buttons to change the mode of operation. Contact your authorized distributor for options.

Start Button



When the **Manual** button is pressed, this **Start** button must be pressed within ten seconds to start the generator set. The generator set starts up normally but without the Time Delay to Start.

In other modes, this button has no effect.

NOTICE

If the Start button is not pressed within the ten seconds of pressing the Manual button, the generator set mode changes to the Off mode automatically.

Manual Button



Press this button to put the generator set into the Manual mode. The **Start** button must then be pressed within ten seconds. Failure to do this results in the control mode defaulting, putting the generator set into the Off mode.

The green lamp above this button is lit when the generator set is in Manual mode.

NOTICE

If the Mode Change access password feature is enabled, the password must be entered before pressing the Start button. See the Passwords and Mode Change section.

Auto Button



Press this button to put the generator set into the Auto mode. In this mode, the generator set is controlled by a remote switch or device (e.g. transfer switch).

The green lamp above this button lights when the generator set is in Auto mode.

Stop Button



Press this button to put the generator set into the Off mode. This disables Auto and Manual modes. The green lamp above this button lights when the generator set is in the Off mode.

If the generator set is running, in either Manual or Auto mode, and the **Stop** button is pressed, the engine shuts down.

Refer to the Selecting Operating Modes section for more information on stopping in Auto or Manual mode.

NOTICE

If possible, hot shutdown under load should be avoided to help prolong the reliability of the generator set.

Power On and Sleep Modes

The operating modes of the control panel and operating software are Power On and Sleep.

Power On Mode

In this mode, power is continuously supplied to the control panel. The control's operating software and control panel lamps/graphical display remain active until the Sleep mode is activated.

Sleep Mode

Sleep mode is used to reduce battery power consumption when the control is not being used and it is in the Off or Auto mode. In this mode, the control's operating software is inactive and the lamps and graphical display on the control panel are all off.

When all conditions are met (i.e. no unacknowledged faults and the control is in the Off/Auto mode), the sleep mode activates after five minutes of keypad inactivity. This length of time is configurable.

To activate the control and view the menu display without starting the generator set, press any control button.

NOTICE

Sleep mode can be enabled/disabled. Contact your authorized distributor for options.

3.2 Operator Panel

The figure below shows the features of the front panel. It includes five lamp indicators; the graphical display with four menu select and seven menu navigation buttons; and six control mode buttons. This display panel enables the operator to look at the status, adjust the settings, and start and stop the generator set.

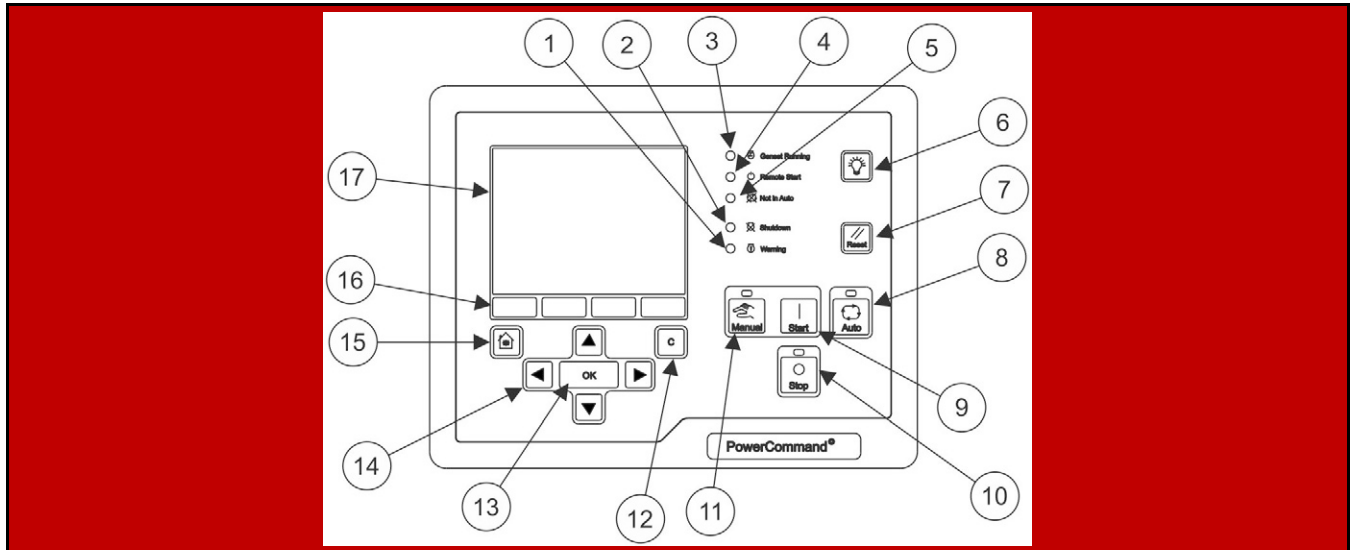

No.	Description	No.	Description
1	Indicator Lamp – Warning	10	Stop Button
2	Indicator Lamp – Shutdown	11	Manual Button
3	Indicator Lamp – Genset Running	12	Previous Menu Button (or Clear)
4	Indicator Lamp – Remote Start	13	Item Select Button (OK)
5	Indicator Lamp – Not in Auto	14	Menu Navigation Buttons (Up, Down, Left, Right)
6	Lamp Test Button/Panel Lamp On-Off	15	Home Button
7	Reset Button	16	Menu Select Buttons (for use with Item 17)
8	Auto Mode Button	17	Graphical Display
9	Start Button		

FIGURE 2. OPERATOR PANEL

Selection Buttons

Four momentary buttons are used to navigate and change the selection in the graphical display:

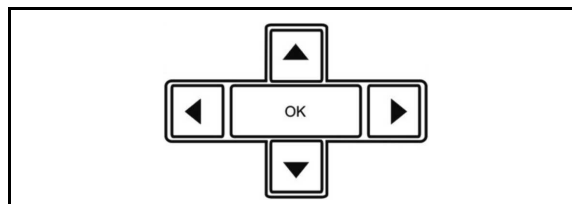

FIGURE 3. SELECTION BUTTONS

Press the **OK** button to select the item that is currently highlighted in the graphical display:

Item	Results of Pressing OK
Menu	Opens the sub-menu or screen
Parameter	Allows adjustment of the parameter (if possible) or prompts for a password
Adjusted Value	Saves the change
Action	The graphical display runs the action or prompts for a password

Default Settings

The operator panel can display SAE or Metric units of measurement and should be set during the initial setup of the generator set. Only trained and experienced personnel are allowed to change the default setting. Contact your authorized distributor.

Status Indicators - PowerCommand 2.3

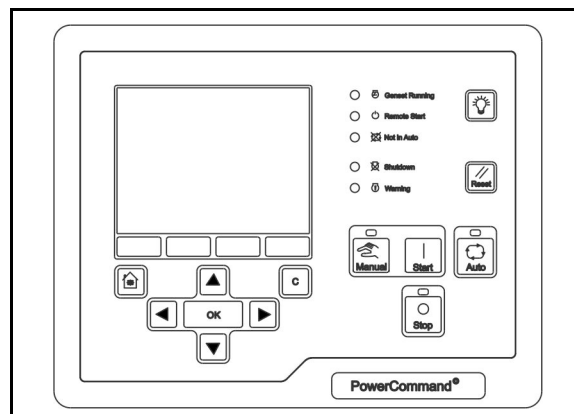

FIGURE 4. OPERATOR PANEL (HMI 320)

Not in Auto

This red lamp is lit when the control is NOT in Auto.

Shutdown Status

This red lamp is lit when the control detects a Shutdown condition. The generator set cannot be started when this lamp is on. After the condition has been corrected, the lamp can be reset by pressing the **Off** button.

NOTICE

When Battle Short mode is enabled and an overridden shutdown fault occurs, the Shutdown lamp lights, even though the generator set continues to run.

Warning 

This amber lamp is lit whenever the control detects a Warning condition. This lamp is automatically shut off when the Warning condition no longer exists.

Remote Start 

This green lamp indicates the control is receiving a **Remote Run** signal. The **Remote Run** signal has no effect unless the generator set is in Auto.

Generator Set Running Lamp 

The green lamp is lit when the generator set is running at, or near, rated speed and voltage. This is not lit while the generator set is warming up or cooling down.

Lamp (LED) Test Button 

Press this button to test the lamps (LEDs). All of the lamps should turn on for five seconds.

Press and hold this for three seconds to turn on or off (to toggle) an external panel lamp.

Reset Button 

Press this to reset any active faults.

If the condition(s) that caused an existing shutdown fault still exists, the generator set generates the fault again.

If the condition(s) that caused an existing warning fault still exists, the generator set generates the fault again, but the operator panel stops displaying it in the graphical display.

Graphical Display and Buttons

[Figure 5 on page 32](#) shows the graphical display and the relevant menu selection buttons.

The graphical display is used to view menus of the menu-driven operating system. System messages (communication, event, and fault) are also shown on the display.

Four momentary soft-key buttons (item 5) are used to change menus, or pages within each screen. These selection buttons are “active” when any text or the up and down triangles (▲ and ▼ in Section 4) are displayed in the graphical display. Some sub-menus do not include any active buttons.

Use the graphical display to view event/fault information, status, screens, and parameters.

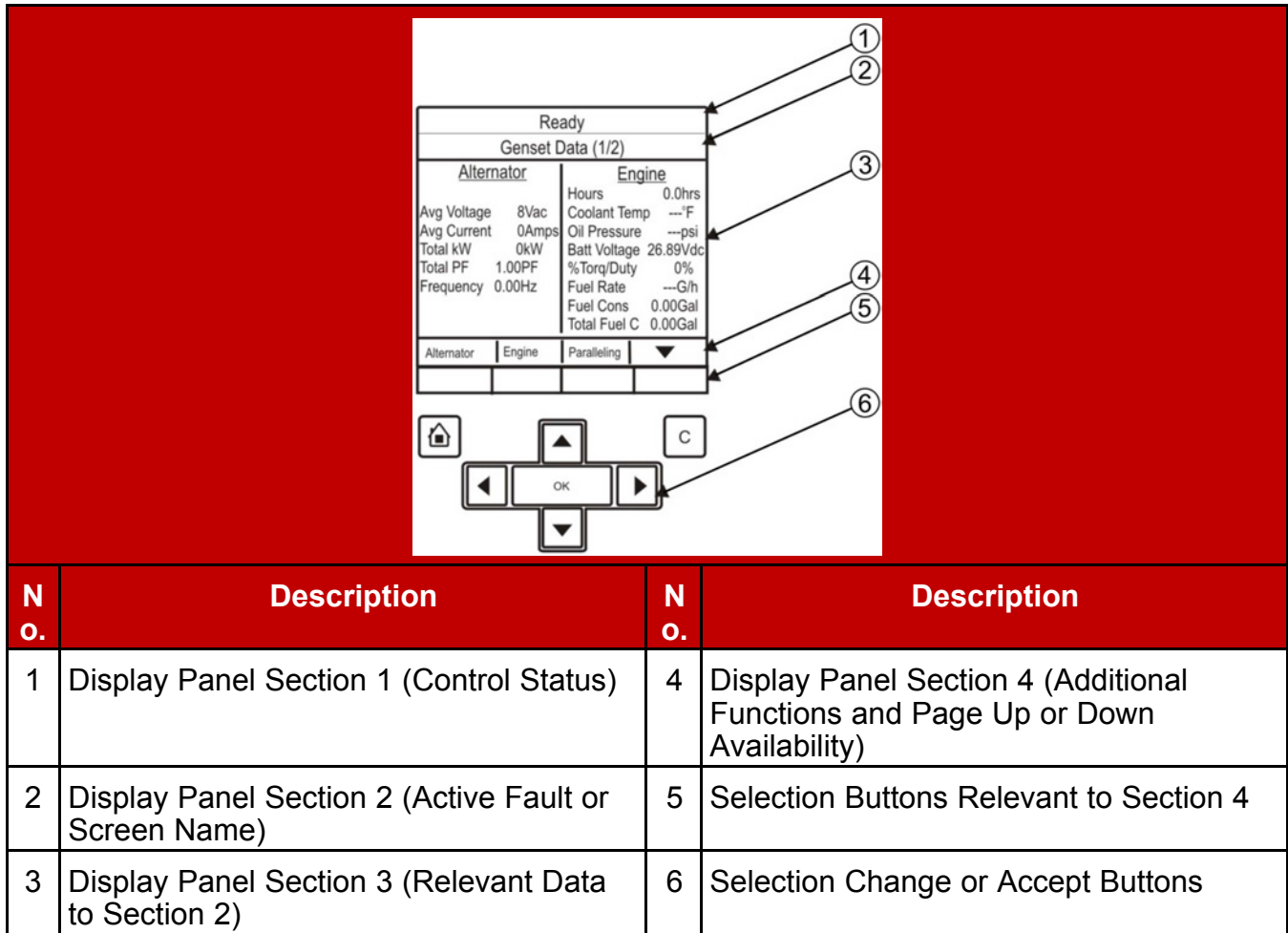

FIGURE 5. GRAPHICAL DISPLAY WITH TYPICAL SCREENSHOT

Section 1 - Control Status

Section 1 displays the status of the controller.

TABLE 13. CONTROL STATUS

Status	Description
Ready	This is the default state. The controller is ready to start the generator set, or it has started one of the start sequences but has not started the engine yet.
Starting	The controller is starting the engine in one of the start sequences, and the engine speed is greater than zero.
Idle Warmup	The controller is raising the engine speed to idle speed, or the engine is running at idle speed in one of the start sequences.
Rated Freq and Voltage	The controller is raising the engine speed to rated speed; the generator set is running at rated speed and voltage; or the controller has started one of the stop sequences but has not started reducing the engine speed yet.
Idle Cooldown	The controller is reducing the engine speed to idle speed, or the engine is running at idle speed in one of the stop sequences.
Stopping	The controller is stopping the engine, and the engine speed is still greater than zero.
Emergency Stop	There is an active shutdown fault.
Setup Mode	The controller is in Setup mode.
Wait to Powerdown	The controller is ready to enter Powerdown mode, but another device is sending a System Wakeup signal.
Off	The controller is in the process of entering power-down mode. The controller is performing some last-second checks.
Demo Mode	The controller is running a demonstration. Every screen is available in the demonstration, and any changes you make in the demonstration will have no effect on the controller. To end the demonstration, the operator panel must be turned off.

Section 2 - Active Fault or Screen Name

Section 2 displays the screen name and information about the last active shutdown fault. If there are no active shutdown faults, it displays the last active warning fault.

If there is an active fault, the operator panel displays the following information about it:

- Fault type
- Event/fault code
- Name of the controller that detected the fault (e.g., the engine ECM unit); this is blank if the controller detected the fault
- Fault name

If you press the **Reset** button, the operator panel stops displaying active warning faults, even if the condition(s) that caused the fault(s) has not been corrected. However, the Warning LED remains on.

The operator panel always displays any active shutdown faults, even if the **Reset** button is pressed.

TABLE 14. ACTIVE FAULT TYPES

Fault Type	Description
Warning	This is a warning fault. (See the Troubleshooting section.)
Derate	This is a derate fault. (See the Troubleshooting section.)
Shutdown	This is a shutdown fault that initiates a Shutdown Without Cooldown sequence. (See the Troubleshooting section.)
Shutdown with Cooldown	This is a shutdown fault that initiates a Shutdown With Cooldown sequence.

Section 3 - Interactive Screen or Menu

Section 3 shows information relevant to Section 2. You can view the operating values for the generator set, navigate through screen and adjust parameters (if permitted).

The default screen is the Genset Data screen.

The following table explains how the operator panel displays when the value of a specific parameter is missing, unexpected, or outside the range allowed for the parameter.

TABLE 15. PARAMETER VALUES THAT ARE MISSING, UNEXPECTED, OR OUTSIDE THE RANGE ALLOWED

Operator Panel	Description
NWF	Network Failure - There is a PCCNet network failure or a CAN (ECM) failure
OORL	Out Of Range Low - The value is less than the lowest allowed value for this parameter
OORH	Out Of Range High - This value is greater than the highest allowed value for this parameter
-- -- --	This value is not applicable

Section 4 - Additional Functions Indicators

Section 4 indicates if additional information or further sub-menus are available by up or down arrows (▲ and ▼). If that particular page or menu has no additional information, then no arrow will be visible at this time.

For example if the graphical display is not big enough to display the screen at one time an up and/or down arrow (▲ and ▼) will be visible. Press the appropriate selection button beneath the graphical display to look at the previous or next page of information in that screen.

Operator Panel - Initial Operator Menu

[Figure 6 on page 36](#) shows the initial menu which is displayed over two pages. Use the soft-key buttons below the up and down arrows (▲ and ▼) to toggle between the two pages.

Use the soft-key buttons below Genset, Alternator, or Engine to short-cut to those menus.

Pressing the **Home** button  from any screen will return the display to the main menu screens.

Initial Menu Data

This menu displays the information available through the menus.

TABLE 16. INITIAL DATA MENU

Name	Description	
History/About	Use this screen to view historical information about your generator set.	
Faults:	If there are no active Faults, these screens will not be available.	
	Active Shutdowns	Use this screen to view active Shutdown faults.
	Active Warning	Use this screen to view active Warning faults.
	History	Use this screen to view faults that have been cleared.
Genset Data	Use this screen to view the status of the generator set.	
Alternator Data	Use this screen to view the status of the alternator.	
Engine Data	Use this screen to view the status of the engine.	
Advanced Status:	---	
	Genset	Use this screen to view power, energy, phase difference, and other detailed generator set information.
	Controller	Use this screen to view sequences of operation, configurable inputs and outputs, and other detailed controller information.
	Engine	Use this screen to view pressures, voltages, temperatures, and other detailed engine information.
Help	Use this screen to obtain more information regarding the operator panel.	

Name	Description
Adjust	The use of these screens is restricted to authorized personnel only.
Genset Setup	
Paralleling Basic Setup	
OEM Setup	
PCCnet Setup	
Modbus Setup	
Display Options	
Clock Setup	
Configurable IO	
Calibration	
Save/Restore	

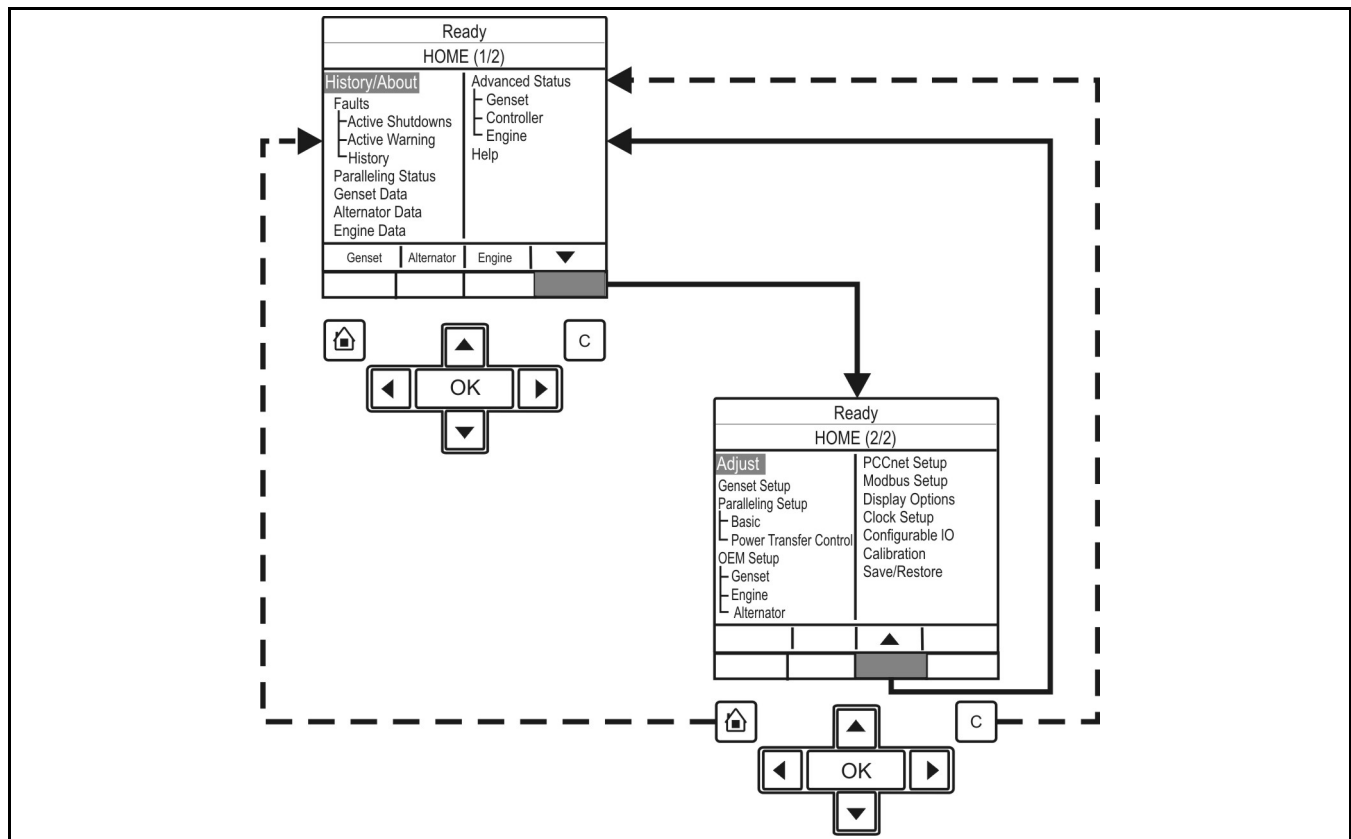



FIGURE 6. INITIAL OPERATOR MENU

- Press the **Home** Button  to return to the main menu at any time.

- Press the **C** Button  to return to the previous menus. Settings will not be saved when this button is pressed.

Operator Panel - Generator Set Data Operator Menu

The Genset Setup Data Menu - Typical Data table below shows a block representation of a typical Genset Data menu. To navigate from the Home menu (HOME [1/2]), press the soft-key button below the function button indicating Genset. This will take you directly to the Genset menu.

The Genset Data menu is displayed on two pages. Use the two soft-key buttons below the up and down arrows (**▲** and **▼**) to toggle between the pages.

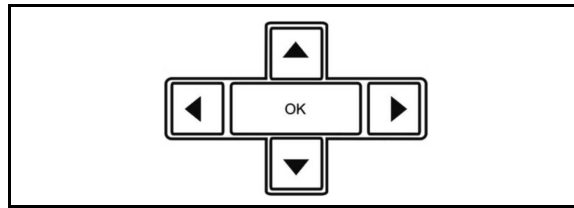

FIGURE 7. SELECTION BUTTONS

Generator Set Data

Use this menu to look at the status of the generator set.

TABLE 17. GENERATOR SET STATUS

Name	Description	Allowed Values
Alternator		
Avg Voltage	Generator set Line-to-Line average voltage	---
Avg Current	Generator set average current	---
Total kW	Generator set total kW	---
Total PF	Generator set power factor	---
Frequency	Generator set frequency	---
Engine		
Engine Hrs	Total engine run time	---
Coolant Temp	Monitor point for Coolant Temperature	---
Oil Pressure	Monitor point for Oil Pressure	0 to ~993 kPa (0 to ~145 PSI)
Batt Voltage	Battery voltage value	---

Name	Description	Allowed Values
% Torq/Duty	Monitor point for the percent engine torque output and the governor percent duty cycle output when used with the HM ECM	-125 - ~125%
Fuel Rate	Monitor point for Fuel Rate	0 - ~845 L/hr (0 - ~223.2 gal/hr)
Fuel Cons.	Fuel consumption since last reset	---
Total Fuel C.	Total fuel consumption since start of engine	---
Generator Set Application Rating		
kW rating	The generator set kW rating	---
kVA Rating	The generator set kVA Rating	---
Rated Current	The value of the generator set application nominal current	---
Generator Set Standby Rating		
kW rating	kW rating for the generator set in Standby configuration	---
kVA Rating	kVA rating for the generator set in Standby configuration	---
Rated Current	The value of the generator set Standby nominal current	---

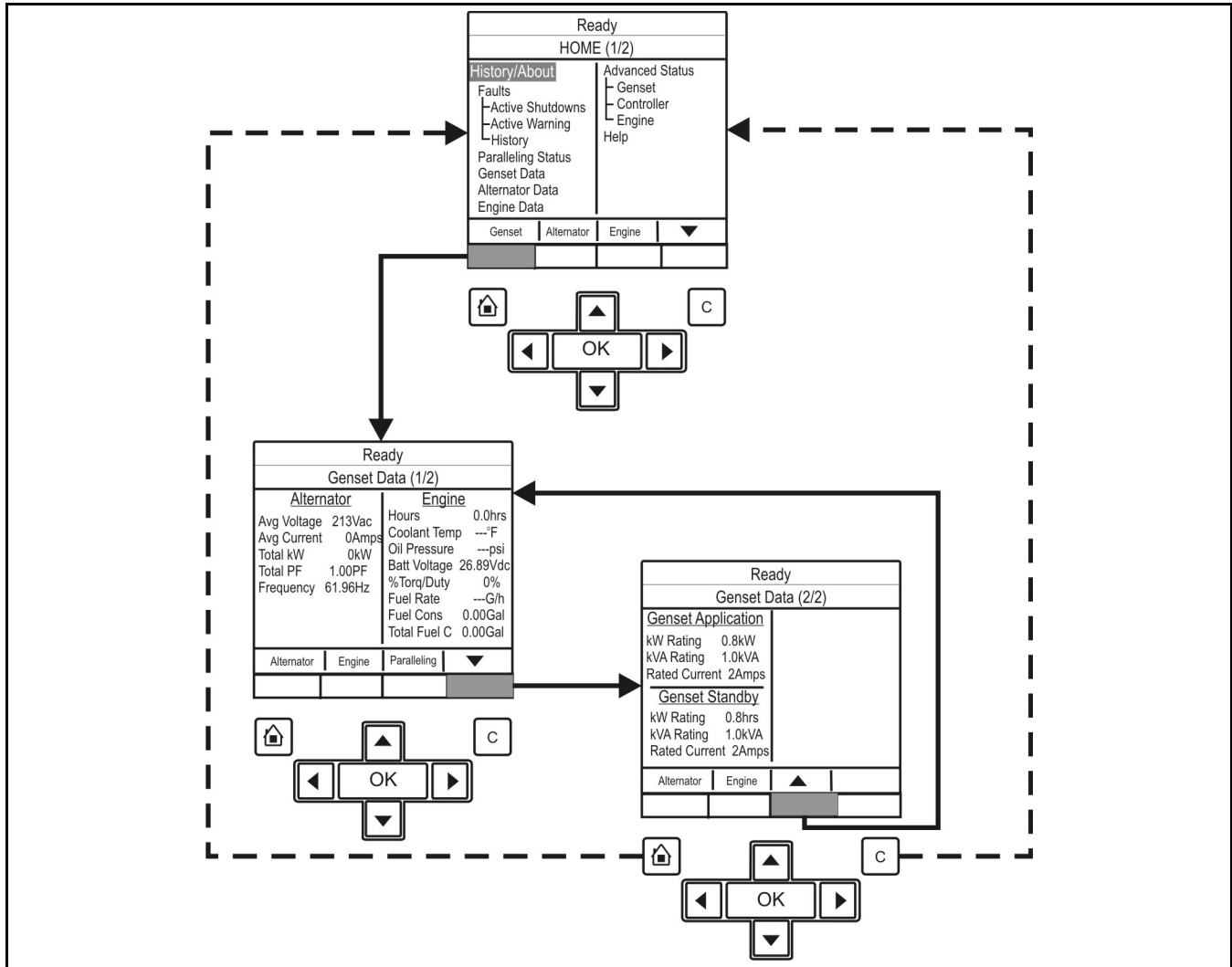



FIGURE 8. GENSET DATA MENU - TYPICAL DATA

- Press the **Home** Button  to return to the main menu at any time.
- Press the **C** Button  to return to the previous menus. Settings will not be saved when this button is pressed.

Operator Panel - Engine Data Operator Menu

The Engine Data Menu - Typical Data figure shows a block representation of a typical Engine Data menu. To navigate from the Home menu (HOME [1/2]), press the soft-key button below the function button indicating Engine. This will take you directly to the Engine menu.

The Engine Data menu is displayed on one page.

Engine Data Menu

Use this menu to look at the status of the engine.

TABLE 18. ENGINE DATA MENU

Name	Description	Allowed Values
Pressure		
Oil	Monitor point for Oil Pressure	0 - ~993 kPa (0 - ~145 psi)
Boost	Monitor point for Boost Absolute Pressure	0 - ~1014 kPa (0 - ~148 psi)
Fuel Rail	Monitor point for Fuel Outlet Pressure	0 - ~249364 kPa (0 - ~36404 psi)
Fuel Inlet	Monitor point for Fuel Supply Pressure	0 - ~993 kPa (0 - ~145 psi)
Coolant	Monitor point for Coolant Pressure	0 - ~993 kPa (0 - ~145 psi)
Crankcase	Monitor point for Crankcase Pressure	-244 - ~260 kPa (-35.67 - ~38 psi)
Ambient	Monitor point for Barometric Absolute Pressure	0 - ~253 kPa (0 - ~37 psi)
Temperature		
Coolant	Monitor point for Coolant Temperature	N/A
Oil	Monitor point for Oil Temperature	-40 - ~210 °C (-40 - ~410 °F)
Manifold	Monitor point for Intake Manifold Temperature—	-40 - ~210 °C (-40 - ~410 °F)
Fuel Inlet	Monitor point for Fuel Temperature	-40 - ~210 °C (-40 - ~410 °F)
Aftercooler	Monitor point for Aftercooler Temperature	-40 - ~210 °C (-40 - ~410 °F)
Other		
Engine Hrs	Total engine run time	
Engine Speed	Monitor point for Average Engine Speed	
Batt Voltage	Battery voltage value	

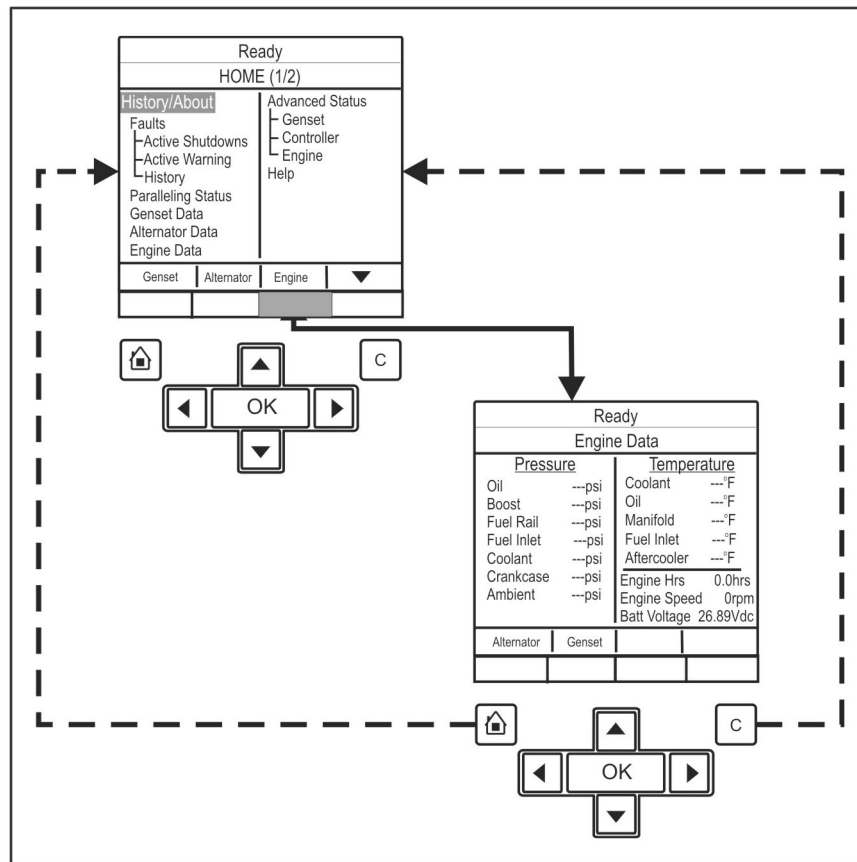



FIGURE 9. ENGINE DATA MENU - TYPICAL DATA

- Press the **Home** Button  to return to the main menu at any time.
- Press the **C** Button  to return to the previous menus. Settings will not be saved when this button is pressed.

History/About Menu

[Figure 10 on page 43](#) shows a block representation of a typical History/About menu.

To navigate from the Home menu, toggle down until the History/About line of text is highlighted, and press the OK button. This information is displayed over three pages. Use the two soft-key buttons below the up and down arrows (▲ and ▼) to toggle between the pages.

This screen displays the historical information about the generator set.

TABLE 19. HISTORY/ABOUT MENU

Name	Description
Starts	Total number of start attempts.
Runs	Total number of generator set runs.
Engine Hours	Total engine run time.
Control Hours	Controller ON time in seconds. Upper limit is 136 years.
Kw Hours	Generator set total net kWh accumulation.
Gen Mod #	Number identifying the model of the generator set. (Password level: 2)
Gen Ser #	Serial number identifying the generator set.
Nominal Voltage	Generator set nominal Line-to-Line voltage.
Wye/Delta	Delta or Wye for Generator set connection.
Rating Select	Selects Standby/Prime/Base application rating.
Contr Type	Used by the PC tool.
Firmware Ver	Version of software loaded into the control. Obtained from PowerCommand® 2.3 Filename.
Calib Part	The unique calibration part number loaded into the control.
Calib Date	The revision date of the calibration part number loaded into the control.
ECM Code	The calibration coded the ECM is sending.
HMI Firm Ver	Parameter: HMI Local Parameter.
HMI Boot Ver	Parameter: HMI Local Parameter.
50 Hz Load Profile*	This shows how long the generator set has been running (50 Hz operation) at various percentages of its rated load.
60 Hz Load Profile*	This shows how long the generator set has been running (60 Hz operation) at various percentages of its rated load.
* When using the Load Profile Graph table (for 50 Hz or 60 Hz), the upper line's value indicates 100% of table.	

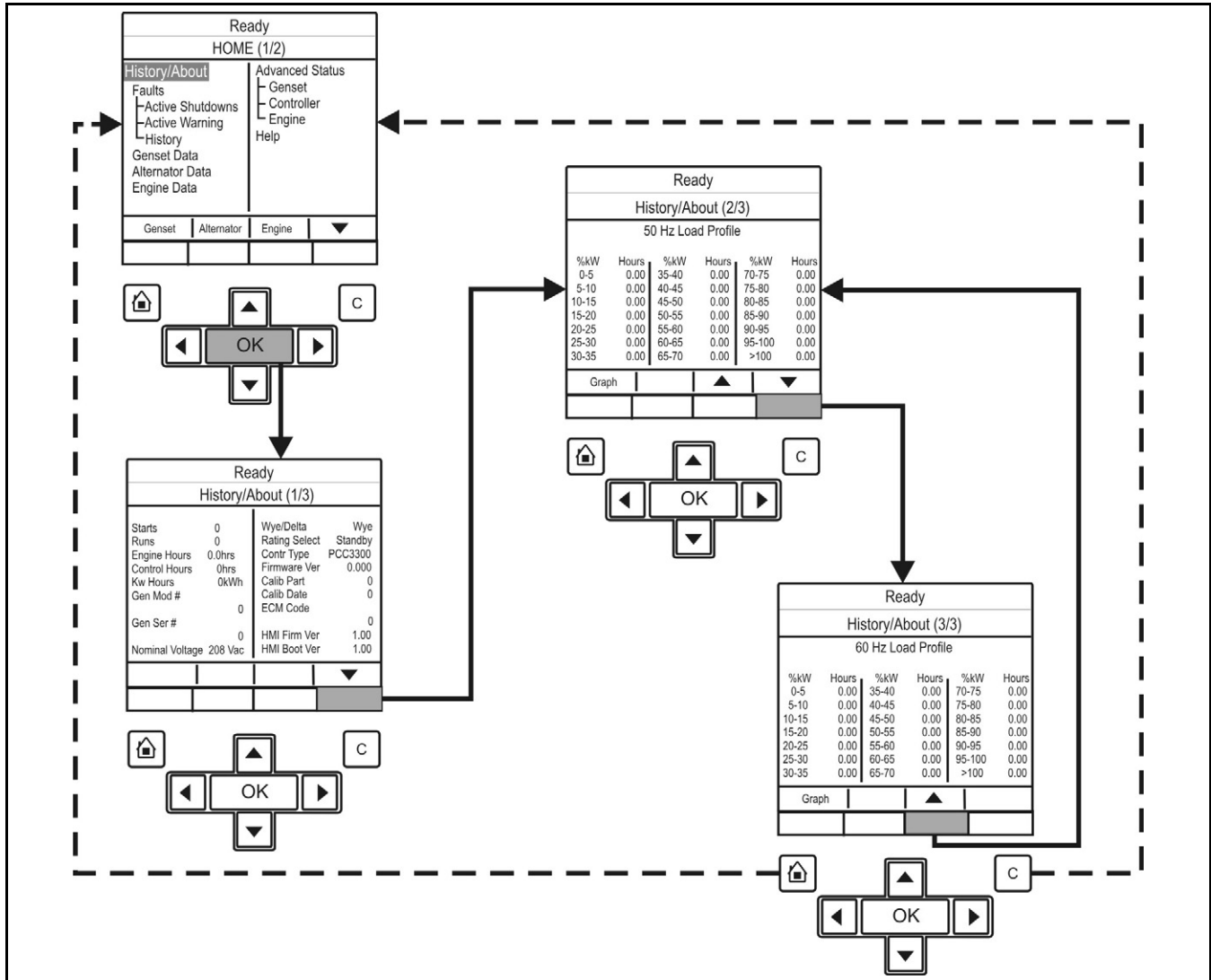



FIGURE 10. HISTORY/ABOUT MENU - TYPICAL DATA

- Press the **Home** Button  to return to the main menu at any time.
- Press the **C** Button  to return to the previous menus. Settings will not be saved when this button is pressed.

Contrast

The Display Options screen allows the contrast to be set.

1. From any Information screen, hold down the up and down arrows simultaneously for two seconds to gain access to the Service Menu screen.
2. Select **Display Options**.
3. From the Display Options screen, select **Adjust** to access the screen variables.
4. Press the right arrow to move to the Contrast variable.

5. Adjust the setting and press **Save** to save any changes. When updating this setting, the functions of the keys are as follows:

TABLE 20. KEY FUNCTIONS ON THE DISPLAY OPTIONS SCREEN

Key/Button	Function
Horizontal right arrow key	Select successive blocks for editing settings on the screen
Left arrow key	Return to the previous screen
+ or - keys	Adjust values on the Adjust screen of the Display Setup screen
Save button	Save any changes; after saving, the Save button changes to the Adjust button

NOTICE

The following screen represents the standard view. If using a remote operator panel, which may be purchased as an option, the screen may look slightly different. This procedure applies to both operator panels.

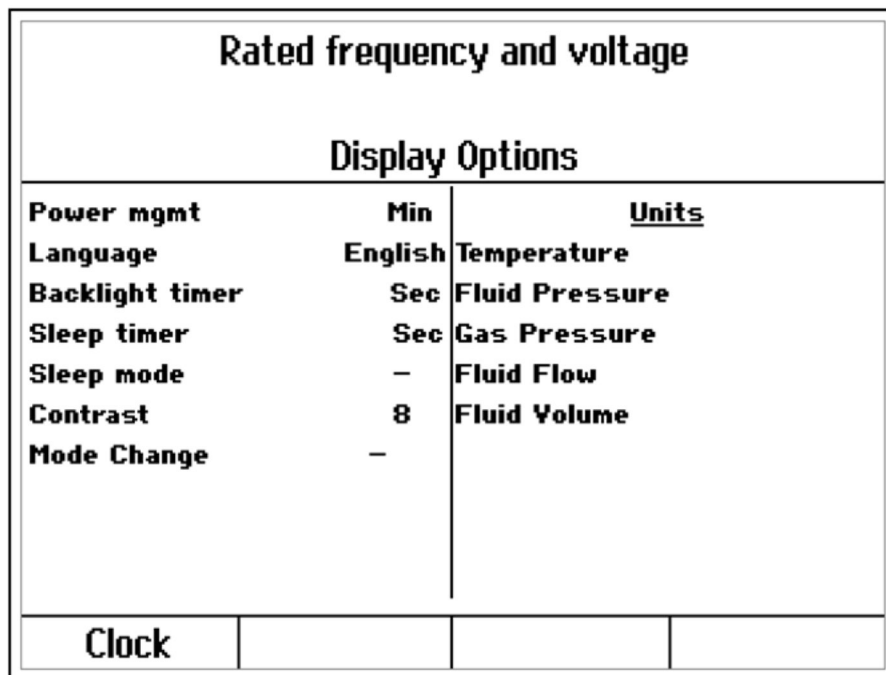

FIGURE 11. DISPLAY OPTIONS SCREEN

Operator Panel - Alternator Data Operator Menu

[Figure 12 on page 46](#) shows a block representation of a typical Alternator Data menu. To navigate from the Home menu (HOME [1/2]), press the soft-key button below the function button indicating Alternator. This will take you directly to the Alternator menu.

The Alternator Data menu is displayed on one page.

Alternator Data

Use this menu to look at the status of the alternator. This menu displays line-to-line voltage, line-to-neutral voltage, current, and generator set power (in kVA). Some values are not available, dependent on the number of phases (one or three) and whether or not the application has current transformers.

TABLE 21. ALTERNATOR STATUS

Name	Description
L1 L2 L3	Alternator terminals
LL (VAC)	Generator set voltage: L1L2, L2L3, L3L1
LN (VAC)	Generator set voltage: L1N, L2N, L3N
Amps	Monitors the current generator set value: L1, L2, L3
kW	Generator set kW: L1, L2, L3
kVA	Generator set kVa: L1, L2 L3
PF*	Generator set power factor: L1, L2, L3
Total kW	Generator set total kW
Total kVA	Generator set total kVA
Total PF*	Generator set power factor
Frequency	Generator set frequency
AVR Duty Cycle	The AVR PWM software command; linear relationship between counts and % duty cycle with 10000 counts = 100% duty cycle
* A negative (-) value indicates a leading power factor; a positive (+) value indicates a lagging power factor.	

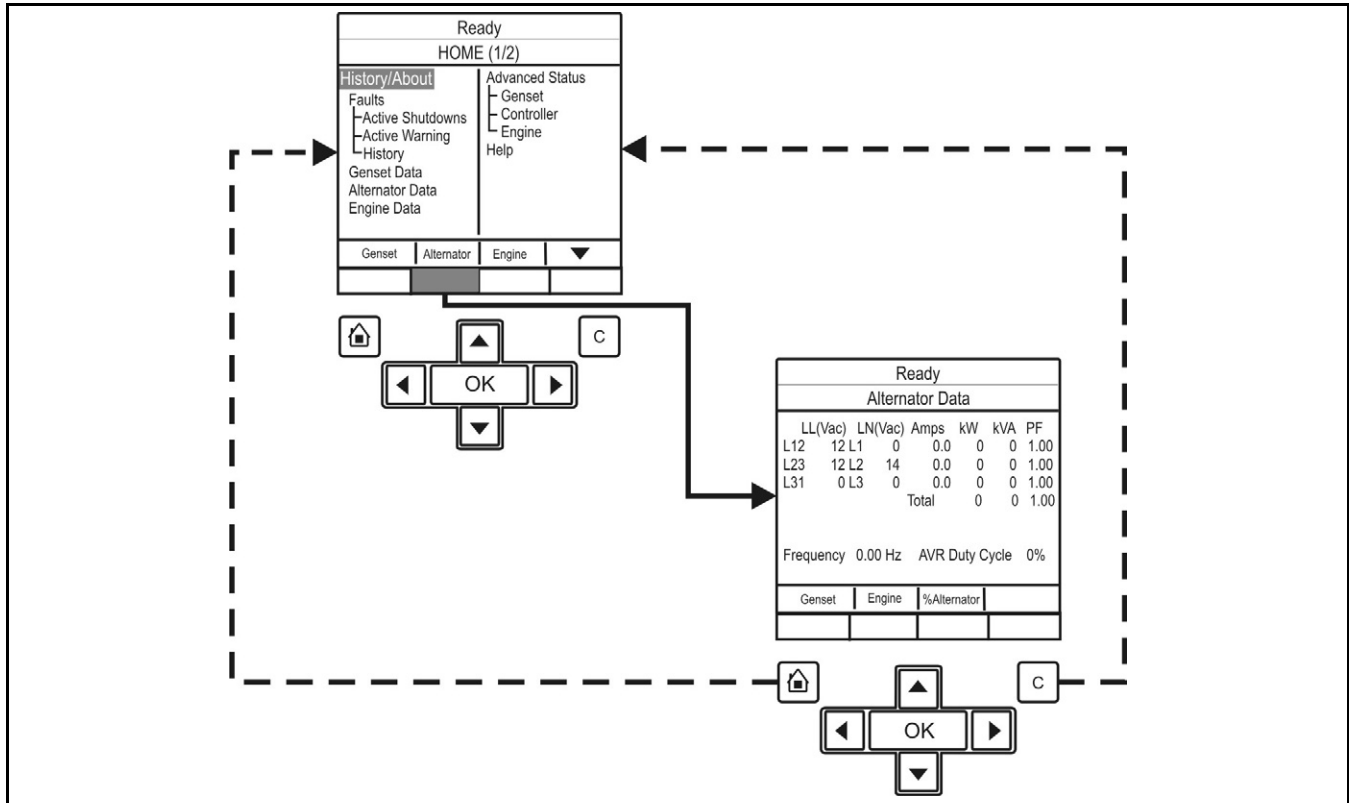



FIGURE 12. ALTERNATOR DATA MENU - TYPICAL DATA

- Press the **Home** Button  to return to the main menu at any time.
- Press the **C** Button  to return to the previous menus. Settings will not be saved when this button is pressed.

Operator Panel - Faults and Warnings Menus

The Faults and Warning menu is divided into three main sub-sections; Shutdown Faults (Active Shutdowns); Warning Faults (Active Warnings); and Faults History (showing up to thirty-two faults that have been cleared).

Shutdown Fault Menu

[Figure 13 on page 47](#) shows a block representation of a typical Shutdown Fault menu.

To navigate from the Home menu, toggle down until the Faults-Active Shutdowns line of text is highlighted, and press the **OK** button.

This will display information regarding the Shutdown fault(s). Use the two soft-key buttons below the up and down arrows (**▲** and **▼**) to toggle between the pages.

This screen displays up to five faults. The same event/fault code may appear multiple times if detected by different sources.

TABLE 22. SHUTDOWN FAULTS

Name	Description
Index	The index number of the fault
Fault	The Fault code
SA	The controller that identified the fault. It is blank if the PowerCommand® 2.3 control identified the fault
Eng Hrs	This is how many hours the engine had run (not necessarily continuously) when the fault was generated
HH/MM/SS	The time the fault was generated
Response	The type of fault that was generated

Note: The name of the fault appears below the rest of the information

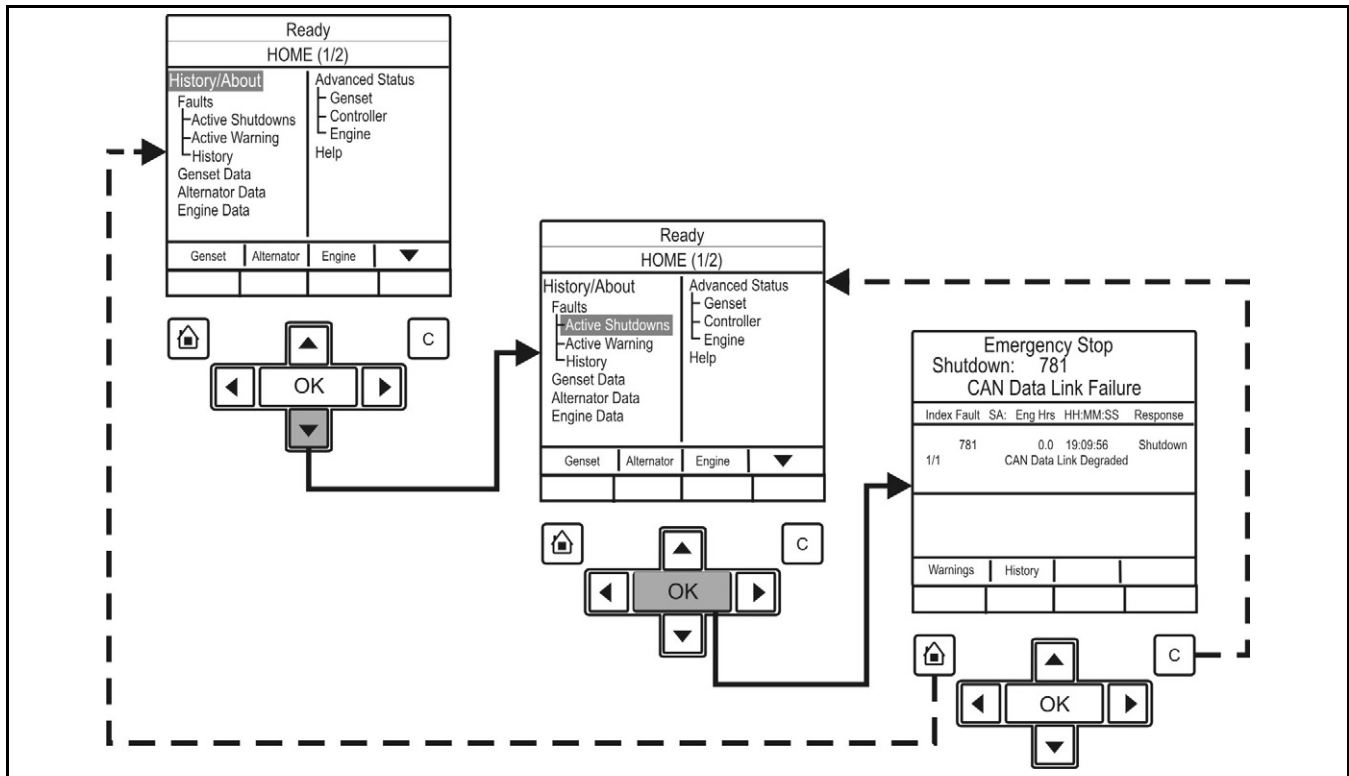



FIGURE 13. SHUTDOWN FAULTS MENU - TYPICAL DATA

- Press the **Home** Button  to return to the main menu at any time.
- Press the **C** Button  to return to the previous menus. Settings will not be saved when this button is pressed.

Fault Messages

A Fault message is an indicator of a Warning or Shutdown condition. It includes the fault type (Warning or Shutdown), fault number, and a short description. It also includes where the fault occurred if the generator set control did not detect the fault and is simply reporting the fault.

Active and acknowledged faults may be viewed in the Faults menu.

Fault Acknowledgement

Shutdown faults must be acknowledged after the faults have been corrected. If in Auto or Manual Run mode, the control must be set to "O" (off). Also, faults are acknowledged when in Auto and the Remote Start command is removed. Faults are cleared from the operator panel display by pressing the ▲, ▼, or  button.

Faults are re-announced if they are detected again after being acknowledged.

Warning Fault Menu

[Figure 14 on page 49](#) shows a block representation of a typical Warning Fault menu.

To navigate from the Home menu, toggle down until the Faults - Warning Fault line of text is highlighted and press the **OK** button. This will then display information regarding the current fault. Use the two soft-key buttons below the up and down arrows (▲ and ▼) to toggle between the pages.

This menu displays up to thirty-two faults. The same event/fault code may appear multiple times if detected by different sources.

TABLE 23. WARNING FAULTS

Name	Description
Index	The index number of the fault
Fault	The Fault code
SA	The controller that identified the fault. It is blank if the PowerCommand® 2.3 control identified the fault
Eng Hrs	This is how many hours the engine had run (not necessarily continuously) when the fault was generated
HH/MM/SS	The time the fault was generated
Response	The type of fault that was generated
Note: The name of the fault appears below the rest of the information	

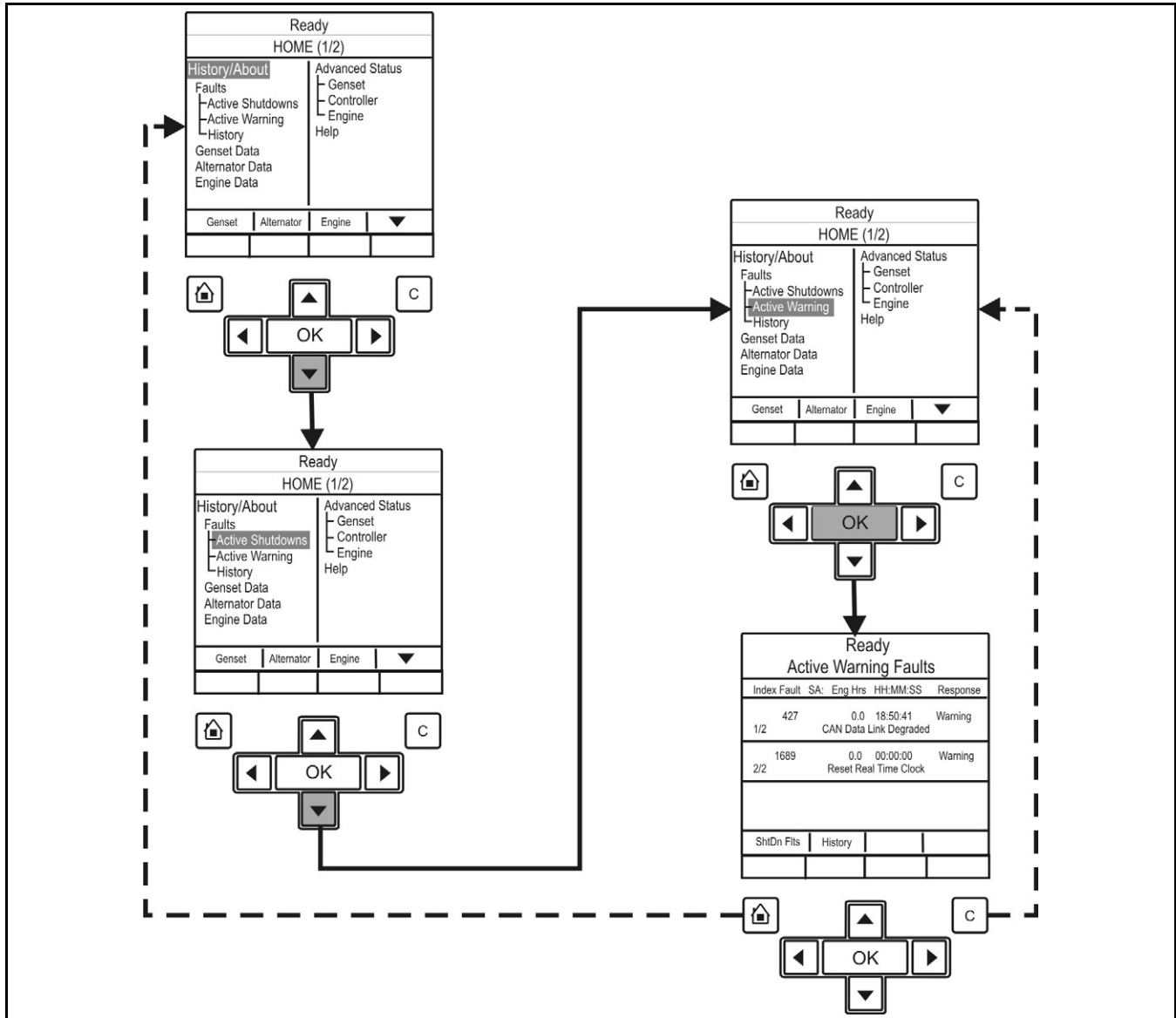



FIGURE 14. WARNING FAULT MENU - TYPICAL DATA

- Press the **Home** Button  to return to the main menu at any time.
- Press the **C** Button  to return to the previous menus. Settings will not be saved when this button is pressed.

Faults History Data Operator Menu

[Figure 15 on page 51](#) shows a block representation of a typical Fault History menu.

To navigate from the Home menu, toggle down until the Faults-History line of text is highlighted and press the **OK** button. This will then display information regarding the fault(s) history. Use the two soft-key buttons below the up and down arrows (**▲** and **▼**) to toggle between the pages.

This menu displays up to thirty-two faults. The same event/fault code may appear multiple times if detected by different sources.

TABLE 24. FAULTS HISTORY DATA

Name	Description
Index	The index number of the fault
Fault	The Fault code
SA	The controller that identified the fault. It is blank if the PowerCommand® 2.3 identified the fault
Engine Hrs	How many hours the engine had run (not necessarily continuously) when the fault was generated
DD/MM/YY	The date the fault was generated
HH/MM/SS	The time the fault was generated
Note: The name of the fault appears below the rest of the information.	

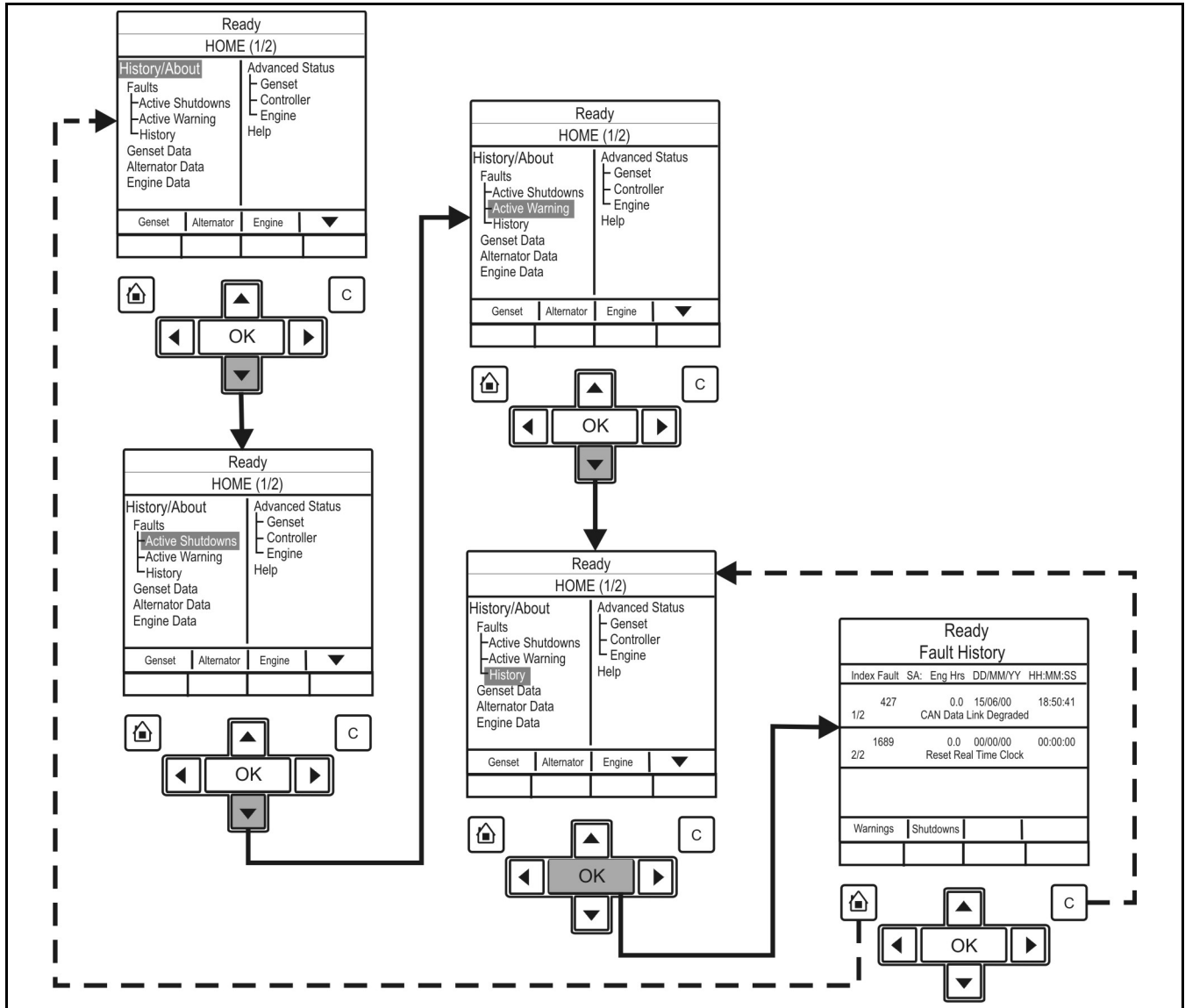



FIGURE 15. HISTORY FAULT MENU - TYPICAL DATA

- Press the **Home** Button  to return to the main menu at any time.
- Press the **C** Button  to return to the previous menus. Settings will not be saved when this button is pressed.

Operator Panel - Adjust Menu

[Figure 16 on page 53](#) shows a block representation of a typical Adjust menu. To navigate from the Home menu (HOME [1/2]), press the soft-key button below the down arrow in the display window. This will show the second page of the Home menu (HOME [2/2]). With the Adjust line of text highlighted, press the **OK** button to display the information.

The Adjust menu is displayed on one page.

NOTICE

If any of these settings require a change, please contact your authorized service center.

NOTICE

You cannot adjust Frequency Adjust or Voltage Adjust if Paralleling Speed Control Mode is set to Synchronize, Load Share, or Load Govern.

TABLE 25. ADJUST MENU

Name	Description	Allowed Values	Default Value
Voltage Adjust			
Genset LL Average Voltage	Generator set Line-to-Line average voltage	N/A	N/A
Voltage Adjust	A trim that allows the user to add/subtract an offset to the nominal voltage when calculating the voltage setpoint	-5 - ~5%	0%
Rated/Idle Sw	---	Rated, Idle	Rated
Exer Switch	---	Inactive, Active	Inactive
Man Warm Byp	---	Normal, Bypass Warmup	N/A
Keyswitch			
Keyswitch Status	---	Inactive, Active	N/A
Frequency Adjust			
Final Frequency Reference	The frequency scaled version of the final speed reference	0 - ~100 Hz	N/A
Frequency Adjust	A method of adding in a frequency offset to the base frequency subject to high and low limit calibrations.	-6 - ~6 Hz	0 Hz
Avr Gain	A trim that allows the user to modify the overall gains of the AVR.	0.05 - ~10	1

Name	Description	Allowed Values	Default Value
Governor Gain	A trim that allows the user to modify the overall gain of the governor.	0.05 - ~10	1
Start Delay	---	0 - ~300 seconds	0 seconds
Stop Delay	---	0 - ~600 seconds	0 seconds

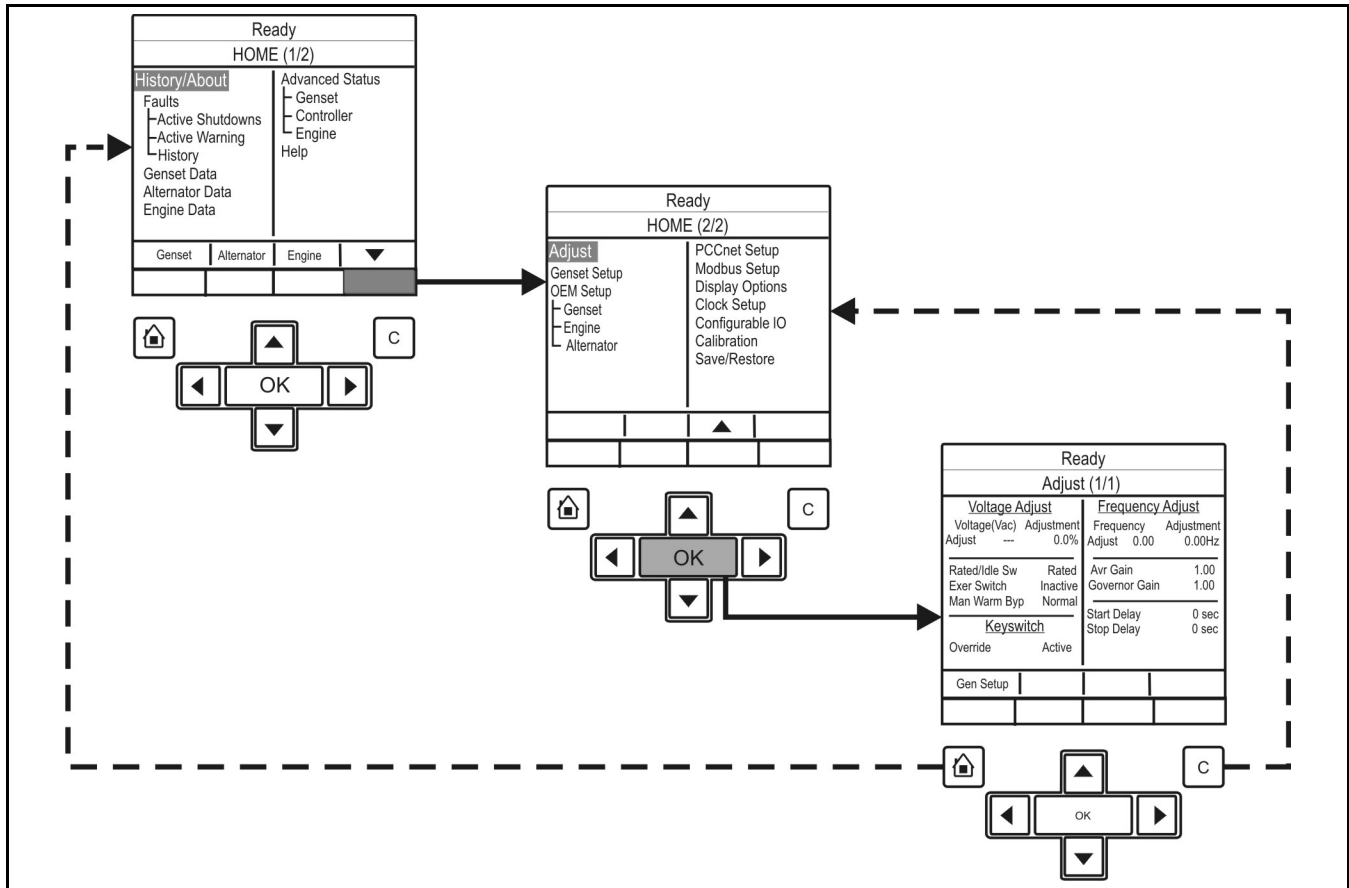





FIGURE 16. ADJUST MENU - TYPICAL DATA

- Press the **Home** Button  to return to the main menu at any time.
- Press the **C** Button  to return to the previous menus. Settings will not be saved when this button is pressed.

Operator Panel - Genset Setup Data Operator Menu

The figure below shows block representations of the Genset Setup Data menu.

1. Page down to the second page of the Home menu (using the two soft-key buttons below the up and down arrows [ and ]). See the Operator Panel - Initial Operator Menu section.

-
2. In the HOME (2/2) menu, using the up and down arrows, toggle down again until the Genset Setup text is highlighted.
 3. With the Genset Setup line of text highlighted, press the **OK** button. This will display the Setup Menu.
 4. Use the two soft-key buttons below the up and down arrows [**▲** and **▼**]) to page through the five pages of the generator Setup data.

NOTICE

if any of these settings need to be changed, please contact your authorized service center.

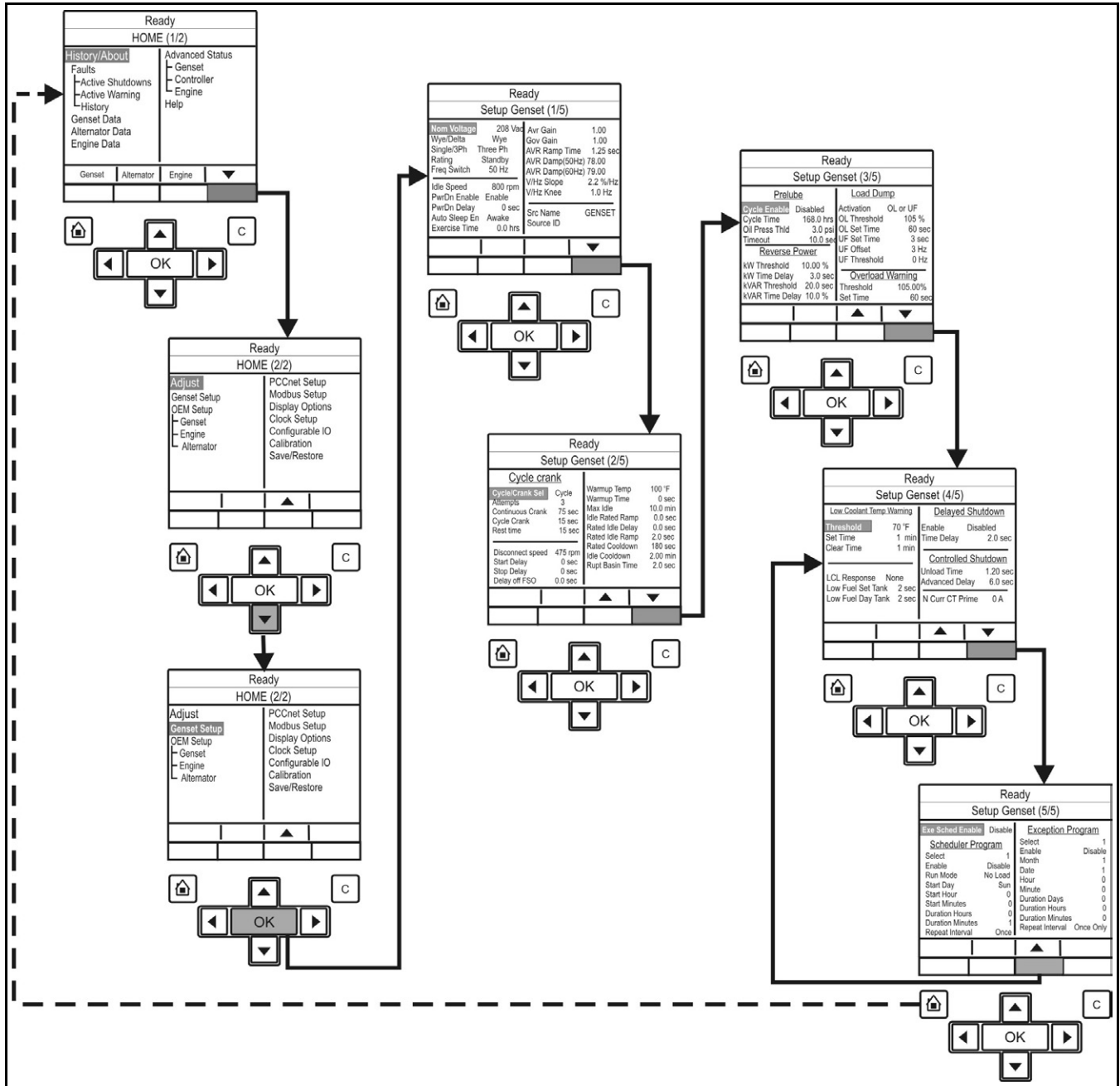

FIGURE 17. GENSET SETUP DATA MENU - TYPICAL DATA

- Press the **Home** Button to return to the main menu at any time.
- Press the **C** Button to return to the previous menus. Settings will not be saved when this button is pressed.

Selecting Operating Modes

Passwords and Mode Change Access

Entering the Mode Change Access Code

The Mode Change submenus are intended for qualified service personnel and site personnel only, and by default will require an Access password. If a password is required, the Mode Change – Access Code menu will appear when you try to switch between Auto, Manual Run, or Stop modes.

To enter the mode access code:

1. With the first character highlighted, press the up and down arrow buttons until the required value is displayed.
2. Press the left arrow button to move to the next numeric character.
3. Repeat steps 1 and 2 until all characters of the Access Code are correct.
4. After you have completed entering the password, press the **OK** button.

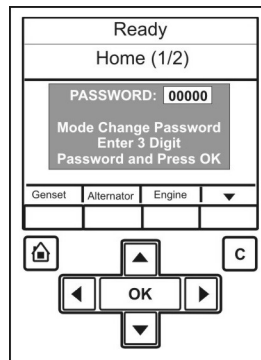

FIGURE 18. MODE CHANGE ACCESS CODE DISPLAY SCREEN

NOTICE

If an incorrect password is entered, the Operator menu that was displayed before Auto, Manual Run, or Stop mode was selected is re-displayed.

Passwords

It is possible for the operator to view every parameter in the graphical display; however, a password may be required before adjustment of a parameter is permitted. The generator set will prompt you if a password is required and inform you of the level of password required.

TABLE 26. PASSWORDS

Level	Description	Comment
0	No password	None required
1	Operator password	Restricted
2	Service password	Restricted
3	Engineering password	Restricted

Selecting Manual Run Mode

NOTICE

When changing modes, the generator set may start or stop without warning. Make sure there is no danger to personnel or equipment should the generator set unexpectedly start or stop.



Press the **Manual** button  and then (within ten seconds) the **Start** button



. This bypasses the "Time Delay to Start" function and activates the engine control system and the starting system.

If the engine does not start, the starter disengages after a specified period of time and the controller indicates a "Fail to Start" shutdown.

The generator set can be configured for 1–7 starting cycles with set times for crank and rest periods for all starting modes (manual/remote). The default setting is 3 start cycles, composed of 15 seconds of cranking and 30 seconds of rest.

NOTICE

The InPower service tool or access to the setup menu is required to change the cycle number, and crank and rest times. Contact your authorized distributor for assistance.



To clear a Fail to Start shutdown, press the **Stop** button  and then press



the **Reset** button .

Before attempting to restart, wait 2 minutes for the starter motor to cool and repeat the starting procedure. If the engine does not run after a second attempt, refer to the Troubleshooting section.

Selecting Auto Mode

NOTICE

When changing modes, the generator set can start or stop without warning. Make sure there is no danger to personnel or equipment should the generator set start or stop.

NOTICE

Make sure that it is safe to do so before proceeding to change the mode.



Press the **Auto** button. This allows the generator set to be started from a remote switch or device (e.g. transfer switch).

In response to the **Remote Start**, the control lights the Remote Start indicator and initiates the starting sequence. This start incorporates a Time Delay to Start function.

NOTICE

The InPower service tool or access to the setup menu is required to change the cycle number, and crank and rest times. Contact your authorized distributor for assistance.

NOTICE

Should a remote start signal be received, the generator set starts automatically. Make sure there is no danger to personnel or equipment should the generator set start without warning.

The starting/stopping sequence for a remote start is as follows:

1. A **remote start** signal is received at the customer connection on the generator set. This input signal is received from a transfer switch, a remote start switch, etc.
2. The Time Delay to Start (0–300 seconds) begins.
3. When the Time Delay to Start has expired, the engine starts. Once it has reached its rated speed and voltage, the generator set is available for use.
4. When the **remote start** signal is removed, a Time Delay to Stop (0–600 seconds) begins. This time delay is used to transfer the load (if connected to another power source) and let the engine cool down.
5. When the Time Delay to Stop has expired, the engine stops.

NOTICE

If the emergency stop or control off button is pressed at any time during the starting/stopping sequence, the engine immediately stops, bypassing the cooldown sequence.

Selecting Off Mode

NOTICE

When changing modes, the generator set can stop without warning. Make sure there is no danger to personnel or equipment should the generator set stop.



Press the **Stop** button to put the generator set into the Off mode. This disables Auto and Manual modes.

If the generator set is running in either Manual or Auto mode, and the **Stop** button is pressed, the engine will shut down. This action may include a cool down run.

NOTICE

Do not perform a hot shutdown under load; a hot shutdown may result in engine damage.

This page is intentionally blank.

4 Operation - PowerCommand 2.3

4.1 Safety Considerations

WARNING

Hazardous Voltage

Contact with high voltages can cause severe electrical shock, burns, or death.

Make sure that only personnel who are trained and qualified to work on this equipment are allowed to operate the generator set and perform maintenance on it.

WARNING

Automated Machinery

Accidental or remote starting of the generator set can cause severe personal injury or death.

Make sure that the generator set cannot be started accidentally or remotely before starting work on the generator.

WARNING

Combustible Gases

Ignition of battery gases is a fire and explosion hazard which can cause severe personal injury or death.

Do not smoke, or switch the trouble light ON or OFF near a battery. Touch a grounded metal surface first before touching batteries to discharge static electricity. Stop the generator set and disconnect the battery charger before disconnecting battery cables. Using an insulated wrench, disconnect the negative (-) cable first and reconnect it last.

CAUTION

Hazardous Voltage

Contact with high voltages can cause severe electrical shock, burns, or death.

Isolate all external electrical supplies prior to access of the control panel. Internal components have live exposed terminations even when the generator set is not running.

NOTICE

Isolator switch only: Do not open the output box while the generator set is running as the isolator switch will cause the generator set to shut down. Keep the output box covers in place during troubleshooting.

NOTICE

Always disconnect a battery charger from its AC source before disconnecting the battery cables. Failure to do so can result in voltage spikes high enough to damage the DC control circuits of the generator set.

NOTICE

Ventilate the battery area before working on or near the battery. Wear goggles. Stop the generator set and disconnect the battery charger before disconnecting the battery cables using an insulated wrench. Disconnect the negative (-) cable first and reconnect it last.

All maintenance tasks must be assessed for health and safety risks; the preventive measures identified must be performed. An additional person is required for any task where doing so significantly adds to the safety of the task.

The installation of a generator set can be designed for remote starting. When troubleshooting a generator set that is shut down, make sure that the generator set cannot be accidentally re-started. Refer to the Locking the Generator Set Out of Service section.

4.2 Introduction to Generator Set Operation

This section describes the operation of the generator set. The text should be read in conjunction with the Control Systems section of this manual.

All indicators, control switches/buttons, and graphical display are located on the face of the operator panel.

4.3 Maintenance

To ensure maximum performance and reliability from your generator set, it is essential that certain components are inspected periodically and, where necessary, maintenance procedures are carried out, as detailed in the Maintenance chapter.

4.4 Operating Recommendations

Running-in

Refer to the Maintenance chapter of this manual. Special "running-in" oils are not recommended for new or rebuilt Cummins engines. Use the same type of oil during "running-in" as is used in normal operation.

The engine should be run at varying loads during the first few hours of operation to allow the components to "bed in." Avoid long periods of light load or full load running particularly during the early life of the engine.

No Load Operation

Periods of no load operation should be held to no longer than 15 minutes. Long periods of no load operation can result in engine and (if fitted) diesel particulate filter damage.

If it is necessary to keep the engine running for long periods of time when no electric output is required, best engine performance will be obtained by connecting a load of at least 30% rated load, but not to exceed rated load. Such a load could consist of a heater element or load bank.

Exercise Period

Generator sets on continuous standby must be able to go from a cold start to being fully operational in a matter of seconds. This can impose a severe burden on engine parts.

Regular exercising keeps engine parts lubricated, prevents oxidation of electrical contacts, and in general helps provide reliable engine starting.

Exercise the set for a minimum of ten minutes off-load at least once a week and for a minimum of 30 minutes with load at least once each month so that the engine reaches normal operating temperatures.

Low Operating Temperatures

NOTICE

Operating engines at idle (650 to 1000 rpm) in cold ambient temperatures wastes fuel, accelerates wear, and can result in serious engine damage. Under low temperature conditions, incomplete combustion will occur, allowing deposits of unburned tars and carbon to buildup on the valve guide and valves, and eventually cause valve sticking.

In cold climates it is critical that the following items be appropriately maintained and selected based on ambient operating temperatures. Check to be sure:

- The battery is properly sized.
- An appropriate mixture of antifreeze is used in the cooling system.
- The proper grade of fuel is being used.
- The correct weight of engine oil is being used.

Use a coolant heater if a separate source of power is available. The optional heater available from Cummins will help provide reliable starting under adverse weather conditions. Make sure the voltage of the separate power source is correct for the heater element rating.

High Operating Temperatures

In high ambient temperatures, when operating at full load, it is normal for the high temperature warning to be given. This indicates that the engine is operating near to its maximum capacity and is normal. If operation in high temperature environments is anticipated, increase the frequency of checks for coolant level, obstructions of cooling air inlets and outlets, and debris at the radiator.

Refer to the generator set nameplate for the maximum operating temperature, if applicable.

General Operating Conditions

The area surrounding the generator set is critical for safety and its performance. Follow the guidelines below.

- Do not stack anything on top of the generator set.
- Do not store anything inside of the generator set.
- Keep areas clear in front of the cool air in and hot air out (free of obstructions, debris, plants, etc.).

NOTICE

All maintenance procedures must be performed or supervised by authorized and trained service personnel only.

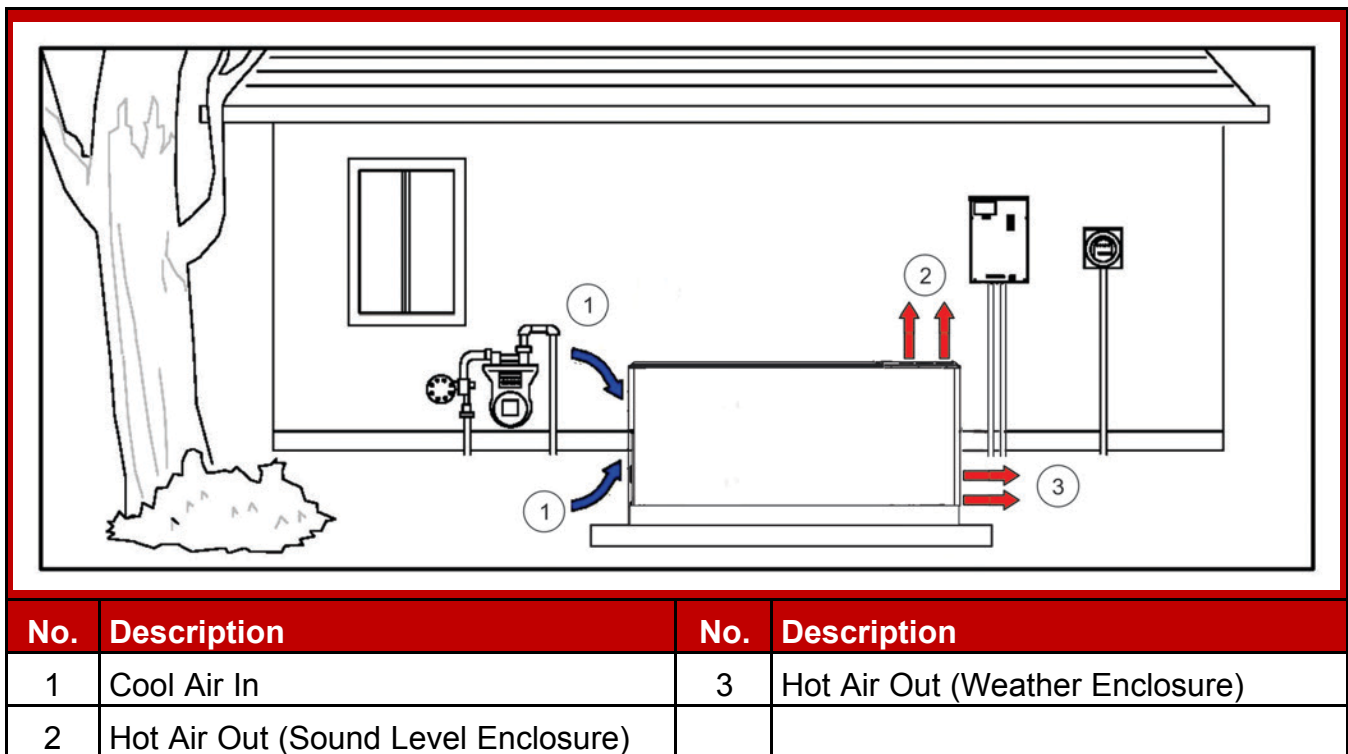

FIGURE 19. EXAMPLE OF GENERATOR SET LOCATION

Emergency Standby Power Rating (ESP) for Variable Load Applications

The Emergency Standby Power Rating (ESP) is applicable for supplying emergency power for the duration of a utility power interruption, between the stated maintenance intervals and under the stated ambient conditions. All maintenance must be carried out as prescribed in Cummins manuals. No overload capability is available for this rating and utility parallel operation is not permitted at the standby power rating. For applications requiring sustained utility parallel operation, the limited time prime power rating or continuous power rating must be utilized as applicable.

This rating is applicable to installations served by a reliable normal utility source. Generator sets should be sized for a maximum average load factor of 80% of the standby power rating with a maximum of 200 hours of operation per year, which includes less than 25 hours per year at the standby power rating. In installations served by unreliable utility sources (where outages last longer or occur more frequently), where operation is likely to exceed 200 hours per year, the prime power rating should be applied. The standby rating is only applicable for emergency and standby applications where the generator set serves as the back up to the normal utility source. Negotiated power outages are not considered as emergencies.

Applicable to All Ratings

The following information applies to all ratings, unless otherwise agreed by the Regional Sales Manager of Cummins in writing:

- When determining the actual average power output of a variable power sequence in any of the ratings above, powers of less than 30% of the emergency standby power are taken as 30% and time at no load shall not be counted.
- Variable load is calculated in accordance with methods and formulas given in ISO 8528-1-2005.
- All three-phase generators are rated for 0.8 power factor lag. Single-phase generators are rated for 1.0 power factor.
- All ratings are based on the following reference conditions:
 - Ambient temperature: 27 °C (81 °F)
 - Altitude above sea level: 150 m (490 ft)
 - Relative humidity: 60%
- If any of the above conditions are exceeded, the output may be subject to de-rate.
- If any of the above conditions are not satisfied, the operational life of the generating set may be reduced.
- Short term parallel operation with the utility for load transfer purposes only is permitted with all ratings.

De-Rating Factors

Engine power and resulting electrical output decrease as ambient temperature or altitude increases. For de-rating factors applicable at specific sites, contact your authorized distributor.

4.5 Sequence of Operation

The generator set is run automatically using a **Remote Start** signal, or manually using the generator set control panel buttons. LEDs are provided on the operator panel to indicate the operating run mode of the generator set. The PowerCommand® control initiates a starter cranking signal and performs an automatically sequenced manual start, under a complete engine protection system combined with full monitoring capability. If a fault is sensed at start-up, the engine is locked out and will not start.

The choice of **Auto** or **Manual Run** mode is decided by authorized personnel during the generator set initial setup. An access code is required to switch between the **Auto**, **Manual Run**, or **Off** modes, and this facility may be permitted or denied by the authorized personnel during the initial setup of the generator set.

4.6 Before Starting

NOTICE

One operator should be in complete charge, or working under the direction of someone who is in charge. Remember that, upon starting the engine, cables and switchgear will become energized, possibly for the first time. Furthermore, equipment that does not form part of the generator set installation may become electrically charged. Only authorized and competent personnel should carry out this work.

NOTICE

Do not use the Emergency Stop button to shut down an engine unless a serious fault develops. The Emergency Stop button must not be used for a normal shut-down as this will prevent a cooling down run in which the lubricating oil and engine coolant carry the heat away from the engine combustion chamber and bearings in a safe manner.

NOTICE

Diesel engines only: Avoid off-load running for other than short periods. A minimum loading of 30% is recommended. The engine must be shut down as soon as possible after the appropriate functions have been checked.

NOTICE

Gaseous engines only: Avoid running the generator set at no-load and light-loads for extended periods.

Before attempting to start the generator set, the operator should read through this entire manual and the specific literature provided as part of the documentation pack supplied with the generator set. It is essential that the operator be completely familiar with the generator set and the PowerCommand® control.

The sub-sections below cover the systems used to start and stop the generator set.

Before starting the generator set, make sure that exhaust and fuel fittings are tight and properly positioned, and that proper maintenance and pre-start checks have been performed.

During starting, automatic checks are carried out for the integrity of various protection systems. The PowerCommand® control will not allow the generator set to continue the starting sequence if the integrity of a sensor is considered to be in doubt.

The generator set can be configured for a number of starting cycles (one to seven) with set times for crank and rest periods for all starting modes (manual/remote). The default setting is for three start cycles, composed of fifteen seconds of cranking and 30 seconds of rest.

NOTICE

The number of starting cycles, and the crank and rest times are set from within the Setup menu. Trained and experienced service personnel are required to change the default setting. Contact your authorized Cummins distributor.

Initial Pre-Start Checks

WARNING

Electric Shock Hazard

Voltages and currents present an electrical shock hazard that can cause severe burns or death.

Make sure that only personnel who are trained and experienced work with distribution voltages. Even after generator set shutdown, an electrical shock hazard may still exist, caused by induced or residual voltage within the alternator or cables. Some interfaces may display zero voltage even when voltages are present.

WARNING

Hot Pressurized Liquid

Contact with hot liquid can cause severe burns.

Do not open the pressure cap while the engine is running. Let the engine cool down before removing the cap. Turn the cap slowly and do not open it fully until the pressure has been relieved.

Before starting, competent personnel must make the following checks to make sure that the unit is ready for operation:

TABLE 27. INITIAL PRE-START CHECKS

Check	Description
Generator Set Grounding	Grounding (earthing) must be checked prior to performing service or inspection procedures that may expose personnel to conductors normally energized with voltages greater than 600 Volts. Contact your authorized Cummins distributor.
Insulation Testing ¹	This must be performed on all generator sets before initial start-up and after the generator set grounding procedure has been completed. Insulation testing for low voltage (less than 600 Volts) generator sets is recommended by Cummins. These tests are used to verify that the windings are dry before the generator set is operated, and to develop a base line for future test comparisons. Contact your authorized Cummins distributor.
Lubrication ²	Check the engine lubrication oil level and ensure that the correct level is always maintained.
Coolant ^{3,4,5}	Check the engine coolant level and ensure that the level is always maintained. Fill the cooling system to the bottom of the fill neck in the radiator fill or expansion tank. Do not check the level while the engine is hot.

¹When wire insulation-testing an alternator, failure to protect the voltage regulator, control and diodes could result in permanent damage to one or more of the electronic components.

²*Generator sets shipped dry only:* They must be filled with the correct type and quantity of oil before use. Be sure to check the oil level before initial start. Failure to fill to the recommended level can result in equipment damage.

³*Generator sets that require a mix of anti-freeze and DCA inhibitor only:* You must comply with Cummins requirements for the correct type and concentration of anti-freeze and DCA inhibitor. Warranty claims for damage will be rejected if the incorrect mix is used. Consult your authorized Cummins distributor for the correct anti-freeze specifications and concentration for your operating conditions.

⁴*Radiators with two fill necks only:* Both fill necks must be filled after the cooling system has been drained.

⁵*Generator sets shipped dry only:* The engine must be filled with the correct type and quantity of coolant before use. Be sure to check coolant level(s), before the initial start.

Operator's Pre-Start Checks

WARNING

Arc Flash and Shock Hazard

Electric arc flash can cause electrical shock, severe burns, or death.

Make sure the alternator is dry before the generator set is operated.

⚠ WARNING***Hot Pressurized Liquid******Contact with hot liquid can cause severe burns.******Do not open the pressure cap while the engine is running. Let the engine cool down before removing the cap. Turn the cap slowly and do not open it fully until the pressure has been relieved.*****NOTICE*****Radiators with two fill necks only: Both fill necks must be filled when the cooling system has been drained.*****TABLE 28. OPERATOR'S PRE-START CHECKS**

Check	Description
Fuel Supply	Make sure that: <ul style="list-style-type: none"> • All the valves required for operation are open and • There are no leaks and that all fittings are tight.
Lubrication	With the engine stationary, check the engine lubrication oil level and make sure that the correct level is always maintained.
Coolant	Check the engine coolant level and make sure that the level is always maintained at the coolant expansion tank. Fill the cooling system to the bottom of the fill neck in the radiator fill or expansion tank. Do not check while the engine is hot.
Cooling Air Inlet/Outlets	Make sure that the cooling air inlets/outlets are unobstructed.
Exhaust Outlet	Make sure that: <ul style="list-style-type: none"> • Exhaust components are secured and not warped; • The exhaust outlet is unobstructed; • No combustible materials are near the system; • Gases are discharged away from building openings; and • There are no leaks and that all fittings are tight.
Batteries	Make sure that the batteries are charged, and that all connections are clean, correct and tight (if applicable).
Auxiliary Powered AC Supplies	Make sure that all auxiliary equipment is receiving power from the customer's supply.
Emergency Stop	Make sure that the emergency stop button is fully operational.

Starting at the Operator Panel (Manual Run Mode)

NOTICE

Make sure that all Pre-start Checks are carried out before starting the generator set. Do not attempt to start the generator set until it is safe to do so. Warn all others in the vicinity of the generator set and connected load equipment that the generator set is about to start.

STARTING IN MANUAL RUN MODE

1. Make sure the main circuit breaker is in the open position.
2. To start the generator set in the **Manual Run** mode:

a. Press the **Manual** button  on the operator panel.

b. Press the **Start** button  within ten seconds.

NOTICE

Failure to press the Start button within this time will result in the generator set changing to the Off mode. Refer also to the Selecting Manual Run Mode section.

NOTICE

If the mode change access code feature has been enabled, enter the access code when prompted. See the Passwords and Mode Change Access section.

3. The PowerCommand® control will initiate a starter cranking signal and will perform an automatically sequenced manual start, under a complete engine protection system combined with full monitoring capability. This will activate the engine control system and the starting procedure. The starter will begin cranking and, after a few seconds, the engine will start and the starter will disconnect.

If the engine fails to start, the starter will disengage after a specified period of time and the control will indicate a Fail to Start shutdown.

To clear a Fail to Start shutdown:

a. Press the **Stop** button .

b. Press the **Reset** button .

4. Before attempting to re-start, wait a minimum of two minutes for the starter motor to cool and then repeat the starting procedure. If the engine does not run after a second attempt, refer to the Troubleshooting section of the operator manual.

DISABLING MANUAL MODE

To disable Manual mode, change to **Auto** or **Off** mode. If the generator set is running when it leaves **Manual** mode, it will continue to run if **Auto** mode has been selected and the remote start signal is active. If there is no active remote start signal, the generator set will stop.

Starting from Remote Location (Auto Mode)

NOTICE

Make sure that all Pre-start Checks are carried out before starting the generator set. Do not attempt to start the generator set until it is safe to do so. Warn all others in the vicinity that the generator set is about to start.

1. To start the generator set in the **Auto Run** mode, select the **Auto** button from



the operator panel. Refer also to the Selecting Auto Mode section.

Once the PowerCommand® control receives a remote start signal, and after a Time Delay to Start, the control will initiate the starting sequence as above. The Remote Start LED will be lit.

NOTICE

If the mode change access code feature has been enabled, enter the access code when prompted. See the Passwords and Mode Change Access section.

NOTICE

When the generator set is operating in the Remote Start mode, removing the Remote Start command does not shut off the engine if the load is more than 10%, the cooldown timer is set to zero, and the control is configured for a single unit (not in parallel). The generator set continues to operate until it runs out of fuel, the E-stop button is used, or the load is removed.

2. To disable **Auto** mode, change to **Manual** or **Off** mode.

Cold Starting with Loads

NOTICE

Make sure that all pre-start checks are carried out before starting the generator set. Do not attempt to start the generator set until it is safe to do so. Warn all others in the vicinity that the generator set is about to start.

The generator set's coolant heater will help provide reliable starting under adverse weather conditions. Be sure the voltage of the separate power source is correct for the heater element rating.

Although most Cummins generator sets will start in temperatures down to $-32\text{ }^{\circ}\text{C}$ ($-25\text{ }^{\circ}\text{F}$) when equipped with engine water jacket coolant heaters, it might take more than ten seconds to warm the engine up before a load can be applied when ambient temperatures are below $4\text{ }^{\circ}\text{C}$ ($40\text{ }^{\circ}\text{F}$).

The **Low Coolant Temp** (Code 1435) message along with the lighting of the **Warning** LED are provided to alert the operator of a possible delay in accepting the load. The engine cold sensing logic initiates a warning when the engine water jacket coolant temperature falls below $21\text{ }^{\circ}\text{C}$ ($70\text{ }^{\circ}\text{F}$). In applications where the ambient temperature falls below $4\text{ }^{\circ}\text{C}$ ($40\text{ }^{\circ}\text{F}$), a cold engine may be indicated even though the coolant heaters are connected and functioning correctly. Under these conditions, although the generator set may start, it may not be able to accept load within ten seconds. When this condition occurs, check the coolant heaters for correct operation. If the coolant heaters are operating correctly, other precautions may be necessary to warm the engine before applying a load.

Checking Coolant Heater Operation

WARNING

Hot Surfaces

Contact with the hot surfaces can cause severe burns.

Avoid contact with hot parts. Allow hot parts to completely cool.

Do not touch the cooling system outlet hose. The coolant heater is operating if radiant heat can be felt with your hand held close to the outlet hose and the engine is not running.

4.7 Stopping

NOTICE

The access code may be required before initiating the Off button sequence. See the Passwords and Mode Change Access section.

NOTICE

Run the generator set at no load for three to five minutes before stopping. This allows the lubricating oil and engine coolant to carry heat away from the combustion chamber and bearings.

Stopping at Operator Panel (Manual Mode)

The control will not respond to any remote stop signal when in **Manual Run** mode. When in **Manual Run** mode, pressing the **Off** button will initiate a normal (Manual) shutdown sequence.

In the **Manual Run** mode the control will not complete the time delay stop.

Reduce engine heat before pressing the **Off** button.

1. Remove the load.
2. Run the set for five minutes.
3. Press the **Off** button.

Stopping from the Operator Panel (Auto Mode)

If the generator set was started in **Auto** mode, press the **Stop** button  once to stop the generator set immediately.

NOTICE

If possible, hot shutdown under load should be avoided to help prolong the reliability of the generator set.

Stopping from a Remote Location (Auto Mode)

If the control receives a remote stop signal, the generator set completes its normal shutdown sequence incorporating a Cooldown run. See the Selecting Auto Mode section. (The remote stop signal is actually the removal of the remote start signal to the control.)

The generator set stops after completing the Time Delay to Stop function (zero to 600 seconds).

The set will remain in the **Auto** mode and subject to a remote start signal, unless the **Stop** button is pressed. If this button is pressed, the generator set will enter the **Off** mode.

NOTICE

The InPower service tool or access to the Setup menus is required to enable and change the time delay start/stop settings. Contact your authorized distributor for assistance.

4.8 Frequency Changing

WARNING

Hazardous Voltage

Contact with high voltages can cause severe electrical shock, burns, or death.

Make sure that only technically trained and experienced service personnel adjust the voltage and frequency settings. These settings may only be adjusted to correspond to the parameters of the installed input power supply.

NOTICE

Any change to the frequency settings must only be carried out by the rental fleet owner.

Within the PowerCommand® control **Set-up** menu is the option to select 50 Hz or 60 Hz running. This option is password protected and is determined at the initial setting up of the set.

The **Set-up** menu is used to control the displaying of a further menu that allows for adjusting the generator set frequency settings.

The **Frequency** menu is designed only for use with rental sets. Changing the parameters on this menu must only be done by trained service personnel.

5 Maintenance

5.1 Maintenance Safety

 **WARNING**

Automated Machinery

Accidental or remote starting of the generator set can cause severe personal injury or death.

Isolate all auxiliary supplies and use an insulated wrench to disconnect the starting battery cables (negative [-] first).

 **WARNING**

Hydrogen Gas

Arcing can ignite explosive hydrogen gas given off by batteries, causing severe personal injury or death. Arcing can occur when cables are removed or replaced, or when the negative (-) battery cable is connected and a tool used to connect or disconnect the positive (+) battery cable touches the frame or other grounded metal part of the generator set.

Insulated tools must be used when working in the vicinity of the batteries. Always remove the negative (-) cable first and reconnect last.

 **WARNING**

Explosive Fumes

Arcing can ignite explosive fumes causing severe personal injury or death.

Make sure hydrogen from the battery, engine fuel and other explosive fumes are fully dissipated before working on the generator set.

 **WARNING**

Working at Heights

Using the incorrect equipment when working at heights can result in severe personal injury or death.

Suitable equipment for performing these tasks must be used in accordance with the local guidelines and legislation. Failure to follow these instructions can result in severe personal injury or death.

⚠ WARNING**Access**

Using the generator set or part of as a means of access when attaching lifting shackles, chains, or other lifting aids, may damage the generator set, causing severe personal injury or death.

Do not use the generator set as a means of access. Failure to follow these instructions can result in severe personal injury or death.

⚠ WARNING**Exposed Terminations**

Some panel internal components may have live exposed terminations even if the generator set is not running. Voltages are present which can cause electrical shock, resulting in personal injury or damage to equipment.

Isolate all external electrical supplies prior to access of the control panel

NOTICE

Only authorized and qualified maintenance technicians who are familiar with the equipment and its operation should carry out maintenance.

NOTICE

Dependent upon the control system fitted, this unit may operate automatically and could start without warning.

NOTICE

Always disconnect a battery charger from its AC source before disconnecting the battery cables. Failure to do so can result in voltage spikes high enough to damage the DC control circuits of the generator set.

All maintenance tasks must be performed, but be sure to assess them for health and safety risks before starting. For example, perform a task with someone present if doing so will add significantly to the safety of the task.

Read, understand, and comply with all Caution, Warning, and Danger notes in this section, the Important Safety Instructions section, and the documentation supplied with the generator set.

Make sure that adequate lighting is available.

Locking the Generator Set Out of Service

NOTICE

Automated Machinery

Accidental or remote starting of the generator set can cause severe personal injury or death.

Isolate all auxiliary supplies and use an insulated wrench to disconnect the starting battery cables, negative (–) cable first.

Before any work is carried out for maintenance, etc., the generator set must be immobilized. Even if the generator set is put out of service by pressing the Off switch on the Operator Panel (or the STOP button if applicable), the generator set cannot be considered safe to work on until the engine is properly immobilized, as detailed in the following procedure.

NOTICE

Refer also to the engine-specific Operator Manual, if applicable. This manual contains specific equipment instructions that may differ from the standard generator set.

To immobilize the generator set:

1. Press the Off switch from the display and then press the E-Stop button to shut down the engine. This will prevent the starting of the generator set regardless of the Start signal source and will therefore provide an additional safety step for immobilizing the generator set. Alternatively, make sure the generator set is in manual mode (which allows it to be started by manually pushing the buttons).

NOTICE

When the E-Stop button is pressed, the Operator Panel indicates the Shutdown condition by illuminating the red Shutdown status LED  and displaying a message on the graphical LCD display.

2. Thoroughly ventilate the generator set before disconnecting any leads.
3. Turn off and disconnect the heater (where fitted) from the AC source before disconnecting the battery cables.
4. Turn off and disconnect the battery charger (where fitted) from the AC source before disconnecting the battery cables.
5. Turn off the fuel supply to the engine.
6. Disconnect the battery. Disconnect the negative (–) cable first, using an insulated wrench.
7. Place warning notices at each of the above locations that state, "Maintenance in Progress – Immobilized for Safe Working."

5.2 Periodic Maintenance

 **WARNING**

Electrical Generating Equipment

Accidental or remote starting of the generator set can cause severe personal injury or death.

Before working on the generator set, make sure that the generator set is in Off mode, disable the battery charger, and remove the negative (-) battery cable from the battery to prevent starting.

The table(s) that follow show the recommended service intervals for a generator set on standby service. If the generator set will be subjected to extreme operating conditions, the service intervals should be reduced accordingly.

At each scheduled maintenance interval, perform all previous maintenance checks that are due for scheduled maintenance.

Some of the factors that can affect the maintenance schedule are:

- Extremes in ambient temperature
- Exposure to elements
- Exposure to salt water
- Exposure to windblown dust or sand

Consult with your authorized Cummins service provider if the generator set will be subjected to any extreme operating conditions, and determine if extra protection or a reduction in service intervals is needed. Use the engine hours shown on the system status screen to keep an accurate log of all service performed for warranty support. Perform all service at the time period indicated, or after the number of operating hours indicated, whichever comes first.

Repair or replace worn, damaged, or improperly functioning components identified during periodic maintenance procedures.

Periodic Maintenance Guidelines

Regularly performing the following periodic maintenance tasks greatly reduces the chances of a generator set shutdown:

- Maintain an appropriate oil level.
- Keep battery connections clean and tight.
- Do not overload the generator set.
- Keep the air inlet and outlet openings clear.

Periodic Maintenance Schedule

NOTICE

Perform maintenance tasks as specified using daily or hourly periods, whichever is sooner.

TABLE 29. PERIODIC MAINTENANCE SCHEDULE

Maintenance Items	After Every 24 Hours of Run Time ¹	After Every 50 Hours of Run Time	12 Months or After 250 Hours ²	2 Years or After 500 Hours ²
Check air cleaner restriction indicator (where fitted): If the indicator shows red, replace air cleaner element and reset the indicator.	■			
Check air intake system for leaks: Visually inspect for signs of wear or damage. Check audibly when the generator set is running. Replace worn or damaged components.	■			
Check coolant level of radiator: If low, top up to coolant system specifications level, with Cummins recommended coolant mix.	■			
Check cooling fan blades: Visually inspect the blades through the guarding for signs of wear or damage. To replace, contact your authorized distributor.	■			
Checking drive belt condition and tension: Visually check belt for evidence of wear or slippage. To replace, contact your authorized distributor.	■			

Maintenance Items	After Every 24 Hours of Run Time ¹	After Every 50 Hours of Run Time	12 Months or After 250 Hours ²	2 Years or After 500 Hours ²
Check radiator airflow: Visually inspect the radiator through the guarding for blockage, debris or signs of wear or damage. To clean or replace, contact your authorized distributor.	■			
Check fuel lines and hoses: Visually check for leaks, worn or damaged hoses. To replace, contact your authorized distributor.	■			
Check engine oil level: If low, top up to engine specifications level with recommended oil.	■			
Check charge alternator: Check visually and audibly when the generator set is running. To replace, contact your authorized distributor.	■			
Check all exhaust components and hardware (fittings, clamps, fasteners, etc.): Visually inspect the exhaust system for signs of wear or damage. Check audibly when the generator set is running.	■			
Check generator set enclosure: Visually check enclosure. Make sure no inlets/outlets are restricted, service access doors are operational. To replace damaged parts, contact your authorized distributor.	■			
Check operation of operator panel: Check display (the system will perform a control panel test on initial activation). Replace component if not functioning properly.	■			

Maintenance Items	After Every 24 Hours of Run Time ¹	After Every 50 Hours of Run Time	12 Months or After 250 Hours ²	2 Years or After 500 Hours ²
Check operation of Emergency Stop Button (where fitted): With the generator set running, press the Emergency Stop button. Check all systems before resetting the fault.		■		
Replace air cleaner.			■ ³	
Check coolant lines and radiator hoses for leaks, wear and cracks: Visually check the hoses. Replace worn or damaged components.			■	
Clean radiator core.			■ ³	
Check water pump for leaks. Check weep holes for evidence of leaks. Replace if leaking.			■	
Verify that the coolant heater has power and is running (where fitted). Check for evidence of leaks. Remove any corrosion from fittings.			■	
Check CCV heater (where fitted). Check for evidence of leaks. Remove any corrosion from fittings.			■	
Check alternator heater (where fitted). Check general condition and wiring connections.			■	
Check battery heater (where fitted). Check general condition and wiring connections.			■	
Check engine oil heater. Check general condition and wiring connections.			■	
Check battery: Check connections to verify that they are secure.			■	

Maintenance Items	After Every 24 Hours of Run Time ¹	After Every 50 Hours of Run Time	12 Months or After 250 Hours ²	2 Years or After 500 Hours ²
Check battery for general condition. Remove any corrosion on terminals with wire brush.			■	
Check electrical connections (battery, starter motor, alternator connections). Check for tight connections, general condition and remove any corrosion.			■	
Replace engine oil and filters. Refer to the Engine Oil section for the procedure.		■ ⁴	■ ⁴	
Check engine ground. Clean as necessary.			■	
Check engine mounts for general condition and for signs of excessive wear.			■	
Check starting motor.			■	
Check turbocharger for signs of leakage. Listen for excessive noise when test running the generator set.			■	
Inspect spark plugs. Replace if showing signs of excessive wear, carbon deposits, oil accumulation or damaged.			■	
Replace spark plugs and spark plug wires.				■
Check charge air cooler for damage and debris.			■	
Check valve lash and adjust if required. See the Valve Clearance Adjustment procedure (service manual only).				■
Check fan drive idler arm and fan belt tensioner for general condition, as well as for excessive play in both.				■

Maintenance Items	After Every 24 Hours of Run Time ¹	After Every 50 Hours of Run Time	12 Months or After 250 Hours ²	2 Years or After 500 Hours ²
Replace cooling system coolant. Check coolant sensor for damage and debris.				■

¹ This interval is based on generator run time: daily in an outage or after every 24 hours of run time.
² To be performed by a qualified Service Technician.
³ Cleaning schedule may be reduced depending on operating conditions/environment.
⁴ After the initial 50 hour interval and every 250 hours thereafter.

Maintenance Record

Record all periodic and unscheduled maintenance and service. See the Periodic Maintenance Schedule for a list of scheduled maintenance frequency.

Date	Engine Hours Meter Reading	Maintenance or Service Performed

Record the name, address, and phone number of your authorized Cummins service center:

Name	Address	Phone

Exercising the Generator Set

NOTICE

Audible engine RPM variation may be heard when there is no load applied. This is normal and does not affect the generator set performance.

Exercising the generator set drives off moisture, relubricates the engine, and removes oxides from electrical contacts. The result is better starting, more reliable operation and longer engine life.

The generator set exerciser mode defaults are as follows.

- **Day:** Tuesday
- **Time:** 2:00 pm
- **Period:** Monthly
- **Run Time:** 5 minutes

Refer to the Exercise Settings section of this manual for more information on setting up the exerciser.

Maintenance Procedures - Daily or When Refueling

Monitor fluid levels, oil pressure, and coolant temperature frequently. During operation, be alert for mechanical problems that could create unsafe or hazardous conditions. The following sections cover several areas that should be frequently inspected for continued safe operation.

NOTICE

Components that have guards against inadvertent touching must be visually inspected only. Do not remove the guards to do the inspection.

General Information

Preventive maintenance begins with day-to-day awareness of the condition of the generator set. Before starting the generator set, check and look for:

- Oil and coolant levels
- Leaks
- Loose or damaged parts
- Worn or damaged belts
- Any change in engine noise or performance

- Generator set appearance

Engine Operation Report

The engine must be maintained in good mechanical condition if the operator is to obtain optimum satisfaction from its use. Running reports are necessary to enable programmed or emergency servicing to be carried out.

Comparison and intelligent interpretation of the running report, together with a practical follow-up action will eliminate most failures and emergency repairs.

Most engine problems give an early warning. Look and listen for changes in engine performance, sound, or appearance that can indicate service or repair is needed. Some engine changes to look for and report on are:

- Low lubricating oil pressure
- Low power
- Abnormal water or oil temperature
- Unusual engine noise
- Excessive use of coolant, fuel or lubricating oil
- Any coolant, fuel, or lubricating oil leaks
- Misfire
- Unexplained frequency fluctuation
- Significant vibration
- Excessive white and/or black exhaust smoke.

5.3 Cooling System

NOTICE

Loss of coolant can allow the engine to overheat if it does not have the protection of a shutdown device. This can cause severe damage to the engine. Maintain coolant level for proper operation of high engine temperature shutdown system. If applicable, see the Model Specifications section for more information.

Radiator Check

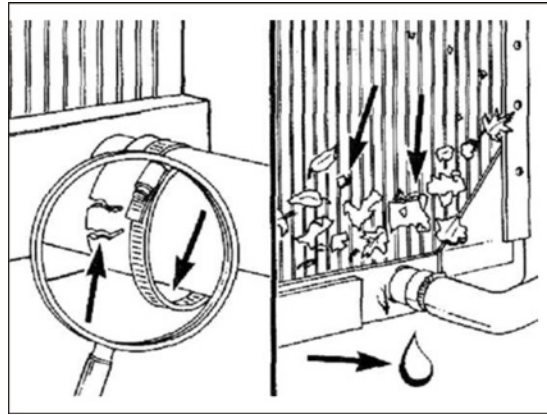

FIGURE 20. RADIATOR CHECK

Check for damaged hoses and loose and damaged hose clamps.

Inspect the exterior of the radiator (through the guarding) for obstructions. During the service life of a radiator a buildup of foreign matter can obstruct the flow of air through the radiator cores, reducing the cooling capability. To continue the efficiency of the radiator, the core will require cleaning.

Cleaning of the radiator core must only be undertaken by suitably trained and experienced service personnel.

Cooling Fan Inspection

⚠ WARNING

Fan Blade Damage

Personal injury can result from a fan blade that has become damaged.

Never pull or pry on the fan; this can damage the fan blade(s) and cause fan failure.

A visual inspection of the cooling fan is required daily. Check for loose rivets or retaining bolts (1), for cracks (2), and bent or loose blades (3).

Contact your authorized dealer if the fan is damaged.

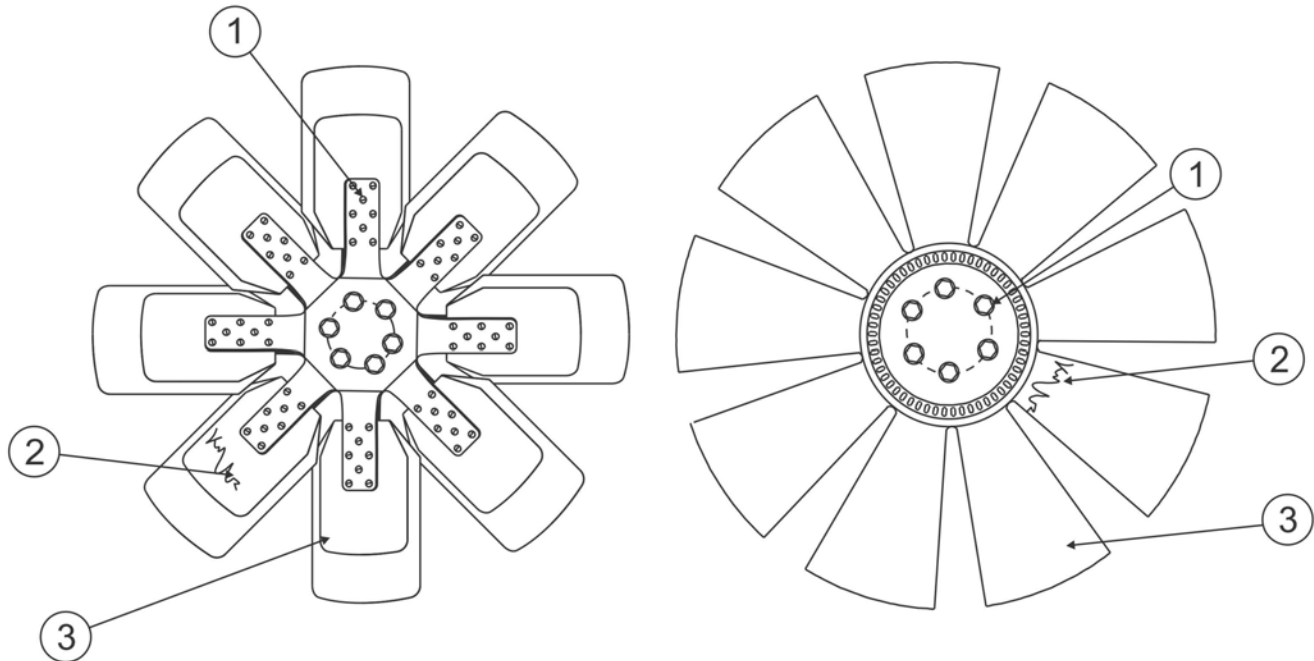

FIGURE 21. COOLING FAN INSPECTION

5.4 Engine Oil

Recommended Engine Oil

Check the oil level prior to starting the generator set to verify that the oil level is between the High and Low marks. The generator set is shipped with engine oil.

The use of quality engine oils combined with appropriate oil and filter change intervals are critical factors in maintaining engine performance and durability.

Cummins Inc. recommends the use of a high quality SAE 5W-40 GEO (all ambients) or SAE 15W-40 GEO (above 40 °F [4 °C]) engine oil for natural gas engines. In addition, oil needs to conform with CES 20074. Refer to the Model Specifications section for oil specification details.

NOTICE

Use of improper oils can result in engine damage. Use only the recommended oils.

NOTICE

Use of GEO 15W-40 oil in ambient temperatures below 40 °F (4 °C) could result in engine turbocharger damage.

Checking Engine Oil Level

WARNING

Automated Machinery

Accidental or remote starting of the generator set can cause severe personal injury or death.

Isolate all auxiliary supplies and use an insulated wrench to disconnect the starting battery cables, negative (-) cable first.

WARNING

Hot Surfaces

Contact with hot surfaces can cause severe burns. Wear appropriate PPE when working on hot equipment and avoid physical contact with hot surfaces.

WARNING

Toxic Hazard

State and federal agencies have determined that contact with used engine oil can cause cancer or reproductive toxicity.

Avoid skin contact and breathing of vapors. Use rubber gloves and wash exposed skin.

WARNING

Toxic Hazard

Crankcase pressure can blow out hot oil and cause severe burns.

Do NOT check oil while the engine is operating.

NOTICE

Check the engine oil level when the engine is not running and is out of Auto mode.

NOTICE

Overfilling can cause foaming or aeration of the oil, and operation below the low mark may cause loss of oil pressure. Do not operate the engine with the oil level below the low mark or above the high mark.

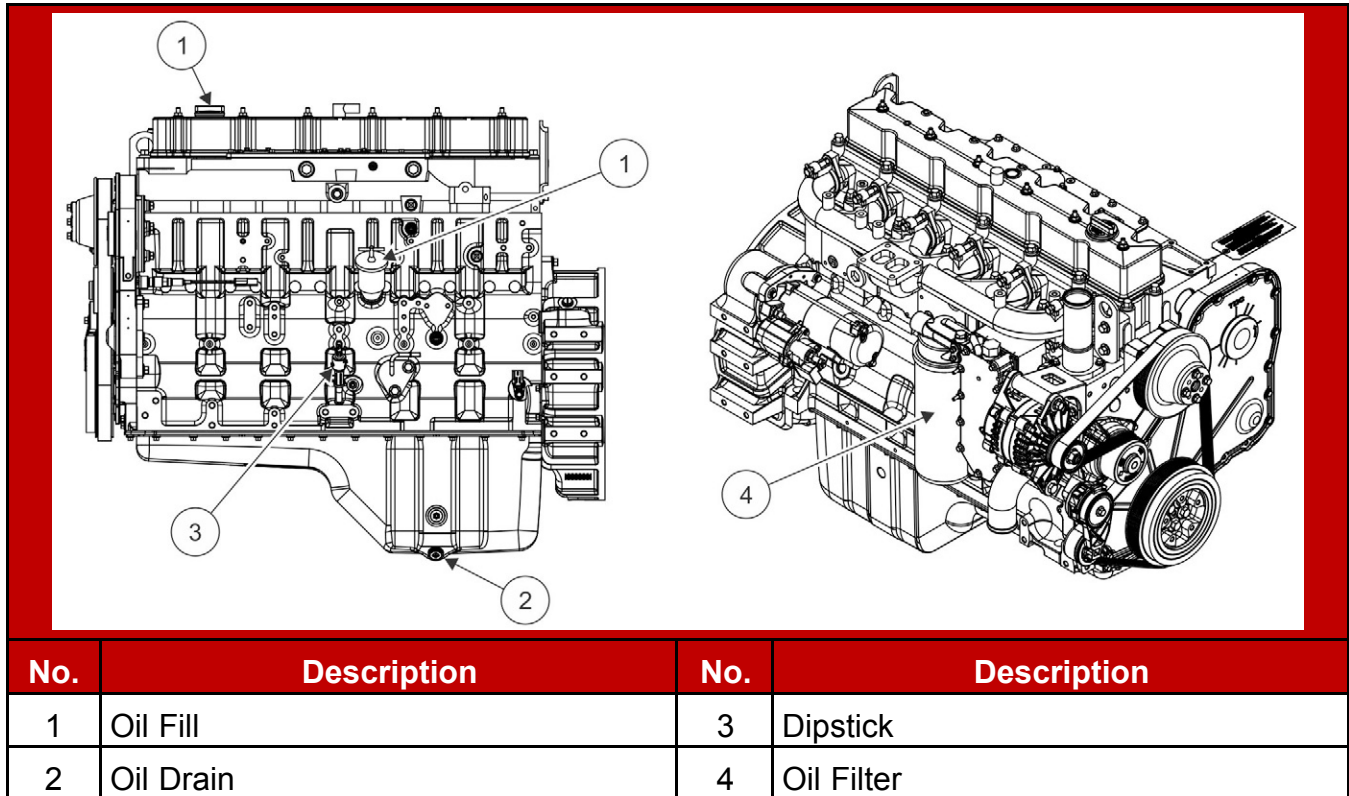

FIGURE 22. ENGINE OIL COMPONENTS

1. Make sure the generator set is shut down and disabled:
 - a. Press the Off switch from the display and then press the E-Stop button to stop the generator set. Allow the generator set to thoroughly cool to the touch.
 - b. Turn off and disconnect the battery charger from the AC source before disconnecting the battery cables.
 - c. Disconnect the negative (–) cable from the battery and secure it from contacting the battery terminals to prevent accidental starting.
2. To check the engine oil level:
 - a. Make sure that the engine has not been running for approximately five minutes.
 - b. Clean off the area surrounding the dipstick port to prevent entry of debris into the oil pan.
 - c. Pull out the dipstick and wipe it clean.
 - d. Reinsert and fully seat the dipstick.
 - e. Remove the dipstick and check the oil level.

NOTICE

The engine oil level indicated on the dipstick should be between the High (18.9 L [20 qt]) and Low (15.1 L [16 qt]) marks.

- f. Reinsert and fully seat the dipstick.

If the engine oil level check shows excessive or insufficient levels of oil (that is, oil level line above the High mark or below the Low mark), oil must be drained or added. Refer to the following sections for instructions and guidelines for draining and adding oil.

Adding or Draining Oil

⚠ WARNING**Hot Surfaces**

Contact with hot surfaces can cause severe burns. Wear appropriate PPE when working on hot equipment and avoid physical contact with hot surfaces.

⚠ WARNING**Hot Engines**

Contact with hot engines can cause severe burns. Ensure that the generator set engine has cooled down before adding or draining the oil.

NOTICE

Too much oil can cause high oil consumption. Too little oil can cause severe engine damage. Keep the oil level between the High and Low marks on the dipstick.

Adding Oil

If the oil level is found to be insufficient, oil must be added.

1. Ensure that the oil fill cap area is clean, and prevent debris from entering the engine.
2. Add the appropriate amount of oil, based on the engine oil level check. Refer to the Checking Engine Oil Level section and the Model Specifications section.
3. Recheck the engine oil level. Based on the results, add or drain oil.
4. Clean up and dispose of any oil in accordance with local/state regulations.

Draining Oil

If the oil level is found to be excessive, oil must be drained from the engine.

1. Detach the oil drain hose from the side of the engine.

2. Place the end of the drain hose into an appropriate container.

Refer to local regulations to determine the appropriate container for used oil.

- Open the oil drain valve to release oil from the engine into the appropriate container.
- Recheck the engine oil level. Based on the results, add or drain oil.
- When a sufficient amount of oil has been drained from the system:
 1. Close the oil drain valve.
 2. Wipe the oil drain valve clean.
 3. Re-attach the drain hose to the side of the engine.
 4. Dispose of the used oil in accordance with local/state regulations.

Changing Engine Oil and Oil Filter

NOTICE

Automated Machinery

Accidental or remote starting of the generator set can cause severe personal injury or death.

Isolate all auxiliary supplies and use an insulated wrench to disconnect the starting battery cables, negative (–) cable first.

⚠ WARNING

Toxic Hazard

State and federal agencies have determined that contact with used engine oil can cause cancer or reproductive toxicity.

Avoid skin contact and breathing of vapors. Use rubber gloves and wash exposed skin.

NOTICE

If the oil and/or oil filter are not reused, dispose of them in accordance with local environmental regulations.

NOTICE

Change the engine oil and filter when the generator set is not running and is out of Remote mode.

NOTICE

Change the oil more often in hot and dusty environments.

NOTICE

Cummins highly recommends that any service or maintenance work be performed by qualified technicians.

1. Open the generator set's circuit breaker to prevent the ATS from transferring to generator set source when manually starting.
2. Before changing the oil, manually start the generator set.
3. Allow the generator set to run for 2 to 5 minutes to warm the engine oil.
4. Make sure the generator set is shut down and disabled:
 - a. Press the generator set's "O" (Off) button to stop the generator set. Allow the generator set to thoroughly cool to the touch.
 - b. Turn off and disconnect the battery charger from the AC source before disconnecting the battery cables.
 - c. Disconnect the negative (–) cable from the battery and secure it from contacting the battery terminals to prevent accidental starting.
 - d. If applicable, disconnect the oil heater from its AC power source (or turn off power).
5. Remove the access panels to get to the drain hose.
6. Open the oil drain cap to release oil from the engine into the appropriate container.

NOTICE

Refer to local regulations to determine the appropriate container for used oil.

7. Close the oil drain cap.
8. Wipe the oil drain cap clean.
9. Place an appropriate container below the oil filter to collect oil as the filter is being removed.
10. Remove the oil filter by turning it counterclockwise.
11. Remove the old gasket if it remains on the engine.
12. Clean the filter mounting surface on the engine block.
13. Make sure the gasket is in place on the new filter and apply a thin film of clean oil to the gasket.
14. Install the new filter until the gasket just touches the block. Turn it an additional 1/2 to 3/4 turn. Do not over-tighten.
15. Remove the container used to collect oil when removing the oil filter.
16. Add the appropriate amount of oil.

NOTICE

Too much oil can cause high oil consumption. Too little oil can cause severe engine damage. Keep the oil level between the High and Low marks.

17. Check the engine oil level. Based on the results, add or drain oil.
18. Remove any oil that has spilled on the generator set during this procedure.
19. Make sure the generator set breaker is open.
20. Reconnect the cables and battery charger:
 - a. Reconnect the engine battery cables, positive (+) cable first.
 - b. Reconnect the battery charger to its AC power source.
21. Reconnect the oil heater AC power or energize its AC circuit.
22. Operate the generator set with no load for approximately 5 minutes to check for leaks at the oil filter or oil drain hose.
23. Shut down the generator set, wait 5 minutes, and then confirm that the correct oil level is in the pan.
24. Check for leaks and repair any that are identified.
25. Dispose of the used oil and oil filter according to local environmental regulations.
26. Re-install the access panels. Torque the fasteners 5.0–6.6 Nm (3.5–5.0 ft-lb).
27. Restore the original generator set settings.
28. Close the generator set breaker.

5.5 Air Intake System

The direct flow air cleaner consists of a primary filter within the air cleaner housing. The air cleaner has been designed for a maximum restriction at 15 in water column (3.7 kPa), at which point the filter element should be changed.

Normal Duty Air Cleaner

Normal Duty Air Cleaner Element Replacement

NOTICE

Holes, loose-end seals, dented sealing surfaces, corrosion of pipes, and other forms of damage render the air cleaner inoperative and require immediate element replacement or engine damage can occur.

NOTICE

Cummins does not recommend cleaning paper-type air cleaner elements.

1. Remove the existing air cleaner:
 - a. Loosen the strap clamp (2).
 - b. Wipe away any debris accumulated around the air cleaner connection to the engine. Ensure that no debris is allowed to enter the body of the air cleaner or the connection on the engine.
 - c. Remove the dirty air cleaner (1).
 - d. Dispose of the dirty element in accordance with local environmental agency requirements.
2. Install the replacement air cleaner (1) as follows:
 - a. Install the air cleaner (1).
 - b. Tighten strap clamp (2). Torque to 2.5 - 3.3 ft-lb (4.3 - 4.65 Nm).

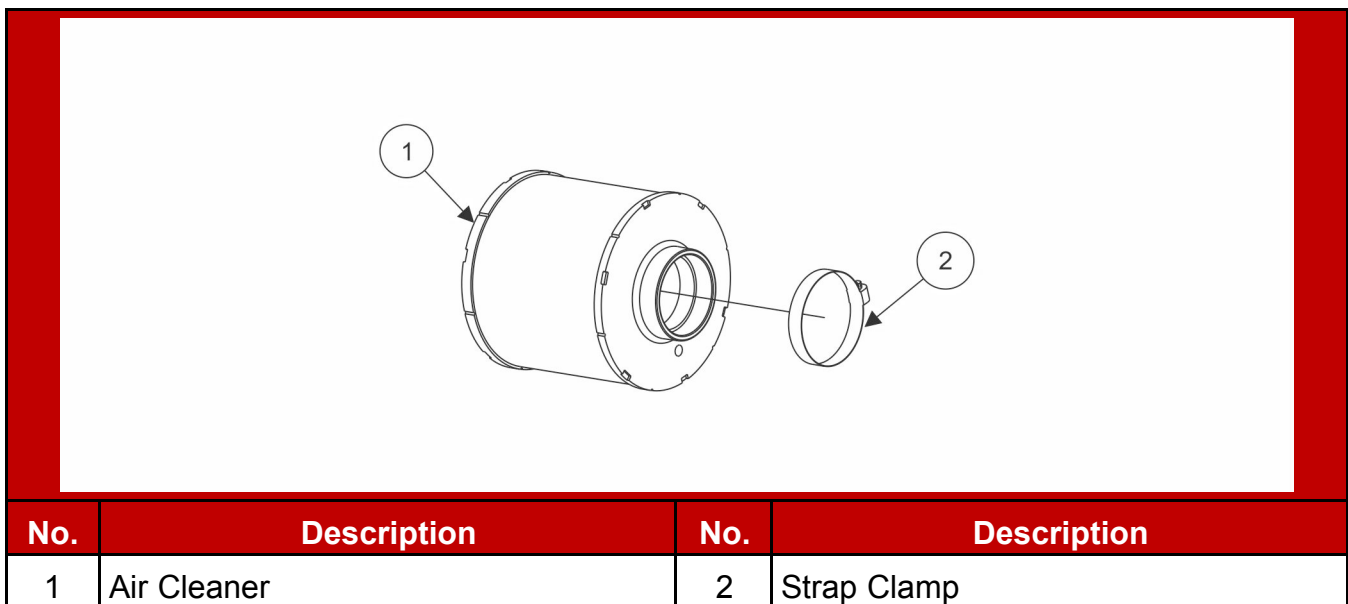

FIGURE 23. EXAMPLE OF NORMAL DUTY AIR CLEANER

Heavy Duty Air Cleaner

Air Cleaner Service Indicator

WARNING

Hot exhaust components.

Exhaust components become very hot when the generator set is in use and remain hot for a period of time after the generator set has been shut down. These components can cause severe personal injury or death from contact.

Allow these components to cool completely before performing any maintenance tasks.

WARNING

Moving parts.

Moving parts can cause severe personal injury or death.

Use extreme caution around hot manifolds, moving parts, etc.

The air cleaner service indicator, available only on heavy duty air cleaners, is located on the air cleaner assembly.

Check the air cleaner service indicator. If the gauge has crossed the red mark, replace the filter element.

Heavy Duty Air Cleaner Maintenance

WARNING

Fall Hazard

Falls can result in severe personal injury or death.

Make sure that suitable equipment for performing tasks at height are used in accordance with local guidelines and legislation.

There is a dust ejector valve (DEV) on the bottom of each filter pre-cleaner that should be checked periodically to make sure it is free of dust and dirt.

When there is a filter pre-cleaner, it includes a primary and secondary element that is checked periodically to make sure they are clean. Refer to the *Periodic Maintenance Schedule* table for additional information.

Heavy Duty Air Cleaner Element Replacement

CAUTION

Holes, loose-end seals, dented sealing surfaces, corrosion of pipes, and other forms of damage render the air cleaner inoperative and require immediate element replacement or engine damage can occur.

NOTICE

Cummins does not recommend cleaning paper-type air cleaner elements.

1. To remove the existing air cleaner element:
 - a. Before disassembly, wipe dirt from the cover and the upper portion of the air cleaner.
 - b. Lift the latch (3) and turn the end cover (4) counterclockwise.
 - c. Pull the end cover (4) away from the housing (1).
 - d. Remove the air filter element (2) from the housing (1).
 - e. Dispose of the dirty element in accordance with local environmental agency requirements.
2. To install the replacement air cleaner element:
 - a. Ensure that no debris enters the filter element or connection point on the air cleaner housing.
 - b. Insert the air filter element (2) into the housing (1).
 - c. Install the end cover (4) onto the housing (1).
 - d. Turn the end cover (4) clockwise until the latch (3) snaps into place.

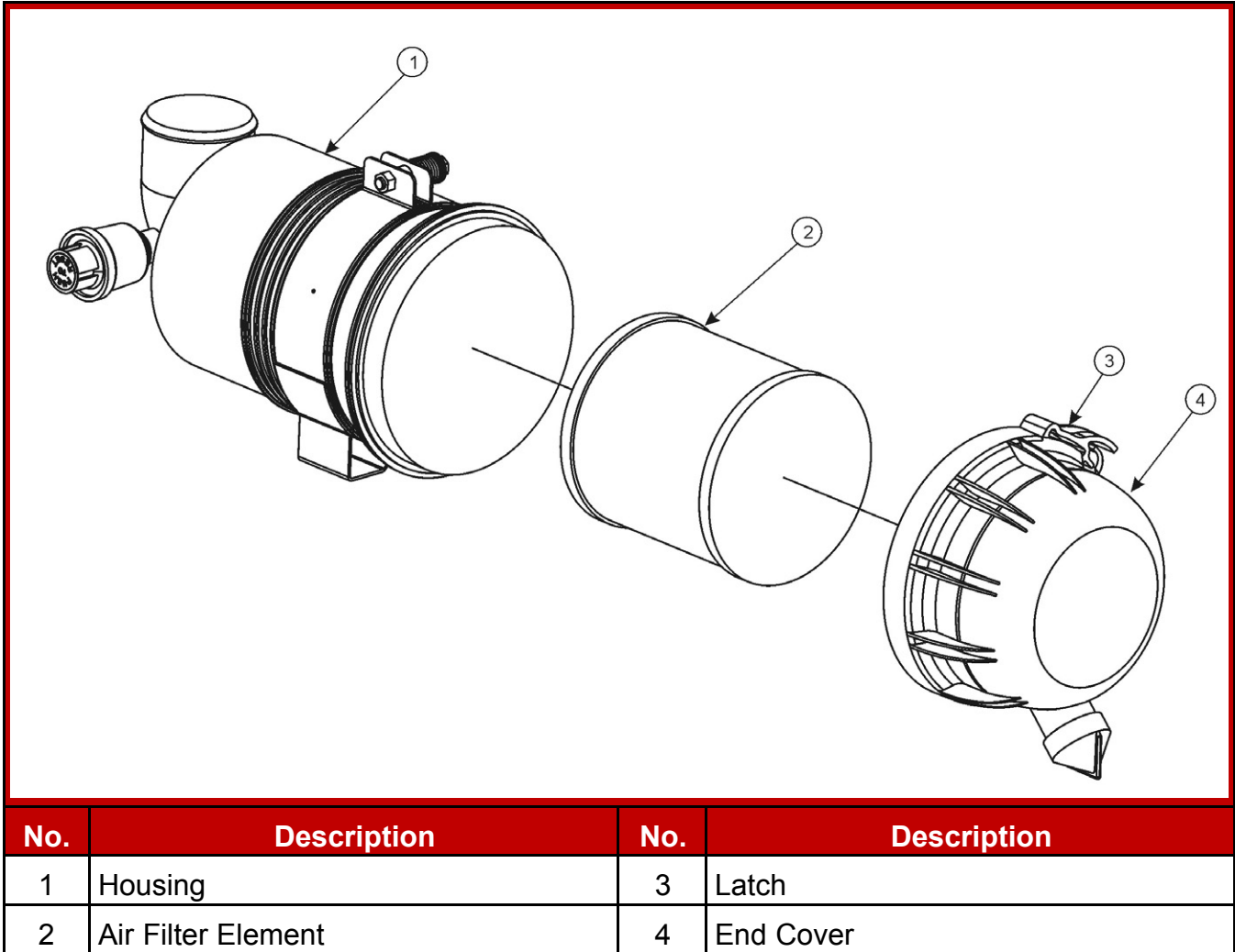

FIGURE 24. EXAMPLE OF HEAVY DUTY AIR CLEANER

5.6 Exhaust System Maintenance

⚠ WARNING

Hot Exhaust Components
Exhaust components become very hot when the generator set is in use and remain hot for a period of time after the generator set has been shut down. These components can cause severe personal injury or death from contact. Allow these components to cool completely before performing any maintenance tasks.

⚠ WARNING***Inhalation of Exhaust Gases***

Inhalation of exhaust gases can result in serious personal injury or death. Be sure deadly exhaust gas is piped outside and away from windows, doors or other inlets to buildings. Do not allow to accumulate in habitable areas.

⚠ WARNING***Moving Parts***

Moving parts can cause severe personal injury or death. Use extreme caution around moving parts, etc.

With the generator set operating, inspect the entire exhaust system visually and audibly including the exhaust manifold, muffler, and exhaust pipe without removing guarding and panels. Check for leaks at all connections, welds, gaskets and joints, and ensure that exhaust pipes are not heating surrounding areas excessively. If any leaks are detected, shut down the generator set (if possible). Contact your authorized dealer and have the leaks corrected immediately.

5.7 Generator Set Output - AC Electric System Checks

1. Check the following while the generator set is operating.

TABLE 30. AC ELECTRIC SYSTEM CHECKS

Check	Description
Frequency	The generator set frequency should be stable and the reading should be the same as the generator set nameplate rating. See the Model Specifications section.
AC Voltage	At no load, the line-to-line voltage, or voltages, should be the same as the generator set nameplate rating.
AC Ammeter	At no load, the current readings should be zero. With a load applied, each line current should be similar.
Panel Lamps	When the operating panel is first connected to the DC supply, the system runs a check by illuminating each of the indicator lamps in turn.

2. If all of the LEDs do not illuminate, replace the operator panel.

5.8 DC Electrical System

WARNING

Combustible Gases

Ignition of battery gases is a fire and explosion hazard which can cause severe personal injury or death.

Do not smoke, or switch the trouble light ON or OFF near a battery. Touch a grounded metal surface first before touching batteries to discharge static electricity. Stop the generator set and disconnect the battery charger before disconnecting battery cables. Using an insulated wrench, disconnect the negative (-) cable first and reconnect it last.

1. Check the harness connections. If any harness connections are damaged, contact your service representative.

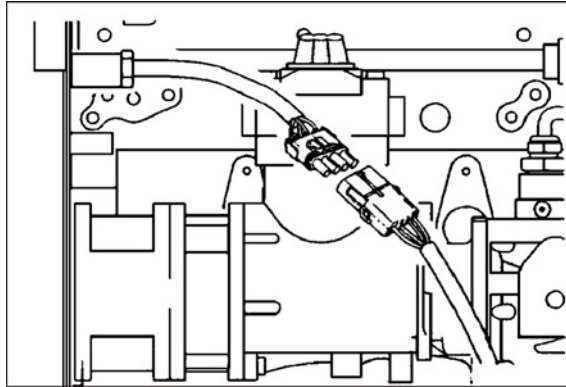

FIGURE 25. CHECK HARNESS CONNECTIONS

2. Check the terminals on the batteries for clean and tight connections. Loose or corroded connections create resistance, which can hinder starting. Clean and reconnect the battery cables if loose, using an insulated wrench. Always disconnect both ends of the negative battery cable. Reconnect one end of the cable to the negative battery terminal and the other end to ground. This will make sure that any arcing will be away from the battery and least likely to ignite explosive battery gases.
3. Check connections at the battery charging alternator.
4. Visually inspect the alternator belt to make sure it is not loose or cracked.

5.9 Batteries

Batteries are an essential part of any standby generator set system. A significant amount of generator set failures are due to battery issues.

It is therefore vital that batteries are stored, commissioned, and maintained as detailed here. Reference should also be made to the battery manufacturer's instructions.

Maintenance free batteries (if supplied with the generator set) need no maintenance for commissioning.

Storage

Batteries must be stored in a cool, dry, well-ventilated place, in the upright position, and with the vent caps securely in place.

Batteries must never be stacked on top of each other and must be protected from the floor by a wooden pallet or suitably thick cardboard sheet.

Safety Precautions

Servicing of batteries are to be performed or supervised by personnel knowledgeable of batteries and the required precautions. Keep unauthorized personnel away from batteries.

General Precautions for Maintenance-Free Batteries

Handling and proper use of batteries is not hazardous if the correct precautions are observed and personnel are trained in their use.

WARNING

Arcing Hazard

Laying tools or metal objects across the battery can cause arcing that may ignite battery gases causing explosions resulting in personal injury.

Never lay tools or metal objects across the top of the battery.

WARNING

Electric Shock Hazard

Voltages and currents present an electrical shock hazard that can cause severe burns or death.

Use tools with insulated handles to prevent the risk of electric shock.

CAUTION

Toxic Hazard

Electrolyte is a dilute sulphuric acid that is harmful to the skin and eyes. It is electrically conductive and corrosive.

Wear full eye protection and protective clothing. If electrolyte contacts the skins, wash it off immediately with water. If electrolyte contacts the eyes, flush thoroughly and immediately with water and seek medical attention. Wash spilled electrolyte with an acid neutralizing agent.

NOTICE

Keep batteries upright to prevent spillage.

Fire Hazard

 **WARNING**

Combustible Gases

Lead acid batteries present a risk of fire because they generate hydrogen gas.

Do not smoke near the batteries. Do not cause flame or spark in the battery area. Discharge static electricity from your body before touching batteries by first touching a grounded metal surface.

 **WARNING**

Before disconnecting a battery, always remove power from the AC powered battery charger.

 **WARNING**

*When putting a battery into service on a generator set, connect the negative lead **LAST**; when removing the battery, disconnect the negative lead **FIRST**.*

Vented Batteries

 **WARNING**

Toxic Hazard

The electrolyte in vented batteries is a dilute sulfuric acid that is harmful to the skin and eyes. It is also electrically conductive and corrosive.

Always:

- 1. Wear full eye protection and protective clothing;*
- 2. If the electrolyte contacts the skin, wash it off immediately with water;*
- 3. If the electrolyte contacts the eyes, flush them thoroughly and immediately with water and seek medical attention; and*
- 4. Wash spilled electrolyte down with an acid neutralizing agent. A common practice is to use a solution of one pound (500 grams) bicarbonate of soda (also known as baking soda or sodium bicarbonate) to one gallon (4 liters) of water.*
- 5. Continue to add the bicarbonate of soda solution until the evidence of reaction (that is, foaming) has stopped.*
- 6. Flush the resulting liquid with water and dry the area.*

Battery Maintenance

WARNING

Automated Machinery

Accidental or remote starting of the generator set can cause severe personal injury or death. Arcing at battery terminals or in light switches or other equipment, and flames or sparks can ignite battery gas causing severe personal injury.

Always follow these procedures to avoid injury and/or damage:

- ***Ventilate the battery area before working on or near the battery.***
- ***Wear safety glasses.***
- ***Do not smoke.***
- ***Switch a work light on or off away from the battery.***

Make sure the generator set is shut down and disabled:

1. ***Press the generator set's red STOP button on the local display to stop the generator set. Allow the generator set to thoroughly cool to the touch.***
2. ***Turn off and disconnect the battery charger from the AC source before disconnecting the battery cables.***
3. ***Disconnect the negative (–) cable from the battery and secure it from contacting the battery terminals to prevent accidental starting.***
4. ***Once work is complete, reconnect the negative (–) battery cable last.***

Always:

- Keep the battery case and terminals clean and dry and the terminals tight.
- Remove battery cables with an insulated wrench or battery terminal puller.
- Make sure which terminal is positive (+) and which is negative (–) before making battery connections, always removing the negative (–) cable first and reconnecting it last to reduce arcing.

NOTICE

If the battery needs to be replaced, make sure that the replacement battery specifications match those found in the Model Specifications in this manual.

Charging

Where a consistent source of AC power is available, Cummins recommends the use of a battery charger to maintain battery condition and charge. Cummins offers several battery chargers.

Where generator sets are used infrequently and a consistent source of AC power is not available, battery recharging must be put on a recharge schedule to ensure that a fully charged condition is maintained.

NOTICE

NEVER allow a battery to become completely flat (fully discharged), or to stand in a discharged condition, or damage will result.

Follow the battery charger operating instructions for proper use.

Battery Replacement

⚠ WARNING***Combustible Liquid***

Burning the battery may cause an explosion. Damage to the casing will release electrolytes which is harmful to the skin and eyes.

When disposing of a battery, do not mutilate or burn it. Comply with all local health and safety regulations/codes during handling or disposal.

Always replace the starting battery with the same number and type (e.g., vented, lead acid, maintenance free) as listed in the specifications section of this document. Properly dispose of battery in accordance with local environment agency requirements.

Always use correct handling techniques to lift and move a battery.

5.10 Spark Plugs

NOTICE

Make sure service personnel are qualified to perform electrical and mechanical service.

The generator set has six spark plugs, all accessible from the top of the engine. The spark plugs must be in good condition for proper engine starting and performance. A spark plug that fouls frequently or has heavy soot deposits indicates the need for engine service.

1. Set the generator set control to the Off position before checking the spark plugs.
2. To prevent cross-threading a spark plug, always thread it in by hand until it seats. Torque the spark plug to 38 Nm (28 lb-ft).
3. Return the generator set control to the desired setting when finished performing maintenance.

5.11 Cleaning the Generator Set Housing

The housing of the generator set housing can be damaged by pressure washing or solvents and other cleaning agents. Only use soap and water or an "all citrus degreaser" to clean the housing.

5.12 Complete System Test

NOTICE

Only authorized and qualified maintenance technicians who are familiar with the equipment and its operation should carry out this test.

A complete system test is recommended to verify that the electrical system is working properly. Testing the system once every 200 hours or every 2 years is required to make sure the transfer switch will transfer the load to the generator set if there is a utility power failure. For more information, see the transfer switch owner manual.

To initiate a complete system test:

1. Before starting:
 - Check the oil level.
 - Verify that fuel related components, such as manual valves, outside of the generator set are open.
 - See the Checklist section in the installation manual.
2. Place the generator set in Standby mode.
3. Switch the main utility disconnect from the ON to the OFF position.
4. Make sure the following occurs:
 - a. The generator set starts.
 - b. After the generator set starts and stabilizes, the load is transferred from the utility to the generator set.
5. Switch the main utility disconnect from the OFF to the ON position.
6. Make sure the following occurs:
 - a. After approximately 5 minutes, the load is transferred back to the utility.
 - b. Once the transfer switch is connected to utility power, after approximately 5 minutes, the generator set stops.

NOTICE

If the test fails, call your authorized Cummins service provider to fix the problem.

6 Troubleshooting

6.1 Avoiding Generator Set Shutdowns

By regularly performing the following periodic maintenance and guidelines, you will greatly reduce the chances of a generator set shutdown:

- Maintain an appropriate oil level.
- Keep battery connections clean and tight.
- Do not overload the generator set.
- Keep the air inlet and outlet openings clear.

Refer to the Maintenance section for more information.

6.2 Control System

The generator set control system continuously monitors engine sensors for abnormal conditions, such as low oil pressure and high coolant temperature. If any of these conditions occur, the control will light a yellow Warning lamp or a red Shutdown lamp and will display a message on the graphical display panel. In the event of an engine shutdown fault (red Shutdown LED), the control will stop the engine immediately.

6.3 Fault Finding

 **WARNING**

Troubleshooting procedures.

Troubleshooting procedures present hazards that can result in severe personal injury or death.

Only qualified service personnel with knowledge of fuels, electricity, and machinery hazards should perform service procedures.

Review safety precautions listed in this manual together with the documentation supplied with the generator set.

For any symptom not listed, contact your authorized dealer for assistance.

Before starting any fault finding, ensure that the following basic checks are carried out:

- All switches and controls are in their correct positions
- Fuel system is connected and fuel is available
- The lubricating oil level is correct
- The coolant level is correct
- The radiator cooling air flow is free from obstruction

- The battery charge condition is satisfactory and the connections are secure
- The generator set electrics and alternator connections are secure
- The panel connections are secure
- The protection circuits have been reset
- Blown fuses have been replaced
- Tripped contactors or circuit breakers have been reset

6.4 Fault Codes - PowerCommand 2.3

Fault Code Introduction

Fault code information, together with warning and shutdown information, is provided in this section to assist in locating and identifying the possible causes of faults in the generator set system.

Refer also to the engine-specific operator manual, if it exists. The engine operator manual contains additional information regarding the running and care of the generator set as well as specific equipment instructions that may differ from the standard generator set.

For any fault codes that occur but are not listed, contact your Cummins service representative.

Code 143 - Engine Oil Pressure Low (Warning)

Logic: Engine oil pressure is below the low oil pressure warning threshold.

Possible Causes:

1. Lubricating oil level is low
2. External leak

Diagnosis and Repair:

1. Lubricating oil level is low
 - a. Check the oil level. Add oil, if necessary.
2. External leak
 - a. Inspect the engine and surrounding area for external oil leaks.
 - b. If a leak is present, contact your Cummins service representative.

Codes 146 and 151 - Engine Coolant Temperature High (Warning or Shutdown)

Logic:

- *Code 146:* Engine coolant temperature has exceeded the warning threshold and duration parameters set in the ECM or control.
- *Code 151:* Engine coolant temperature has exceeded the shutdown (alarm) threshold for high coolant temperature.

Possible Causes:

1. High ambient temperature
2. Enclosure air intake blocked
3. Coolant level below specification
4. Blocked radiator
5. Blocked enclosure air discharge
6. Broken or loose fan belt

Diagnosis and Repair:

1. High ambient temperature
 - a. Reduce loads or recirculation of discharge air to generator set.
2. Blocked enclosure air discharge
 - a. Inspect for dirt, debris, or obstructions.
 - b. Remove blockage or snow/ice buildup if applicable.
3. Coolant level below specification
 - a. Check coolant level.
 - b. Add coolant if applicable.
4. Blocked radiator
 - a. Inspect for dirt, debris, or obstruction.
 - b. Remove blockage or winterfront if applicable.
5. Enclosure air discharge blocked
 - a. Inspect for dirt, debris, or obstructions.
 - b. Remove blockage or snow/ice buildup if applicable.
6. Broken or loose fan belt
 - a. Inspect belt(s) for damage, wear, and proper tension.
 - b. Repair or replace belt(s) if damaged or worn.

Code 197 - Coolant Level Low (Warning)

Logic: Coolant level sensor signal is showing a low coolant level for greater 10 seconds.

Possible Cause:

1. Low coolant

Diagnosis and Repair:

1. Low coolant
 - a. Remove radiator cap and check that coolant is up to the required level.

Code 359 - Fail to Start

Logic: If the engine has failed to start the fault 359 (shutdown) becomes active.

Possible Causes:

1. Battery voltage is low, interrupted, or a bad connection
2. Low pressure level
3. Fuel system restriction is above normal
4. Customer supplied fuel shutoff valve solenoid malfunction
5. Air intake system restriction is above normal
6. Incorrect starter disconnect speed
7. Incorrect PCC or ECM calibration
8. Poor fuel quality

Diagnosis and Repair:

1. Make sure the AC battery charger is connected and functioning.
2. Make sure the fuel pressure is adequate.
3. Remove any dirt, debris or blockage from the air intake and air filter.
4. If the previous steps do not resolve the problem, contact your Cummins service representative.

Code 415 - Engine Oil Pressure Low (Shutdown)

Logic: Engine oil pressure is below the low oil pressure shutdown threshold.

Possible Causes:

1. Lubricating oil level is low
2. External leak

Diagnosis and Repair:

1. Lubricating oil level is low
 - a. Check the oil level. Add oil, if necessary.
2. External leak
 - a. Inspect the engine and surrounding area for external oil leaks.
 - b. If a leak is present, contact your Cummins service representative.

Code 441 - Battery Voltage Low (Warning)

Logic: Battery voltage is low.

Possible Causes:

1. Loose or damaged battery cable connections
2. Battery charger not connected (if equipped)
3. Battery not completely charged

4. Battery is old and does not maintain a charge

Diagnosis and Repair:

1. Loose or damaged battery cable connections
 - Inspect the battery cable connections for corrosion and loose connections. Adjust or repair if needed.
2. Battery charger not connected (if equipped)
 - a. Make sure that the battery charger is connected to the AC power supply.
 - b. Make sure that the battery charger is connected correctly to the battery.
3. Battery not completely charged
 - Using a voltmeter or multimeter, determine if the voltage is below 11 V. If so, recharge the battery.
4. Battery is old and does not maintain a charge
 - Replace the battery.

Code 442 - High Battery Voltage

Logic: Battery voltage is high.

Possible Causes:

1. Incorrect battery voltage setup
2. Battery voltage above high battery voltage threshold
3. Battery charger overcharging battery
4. Faulty engine DC alternator

Diagnosis and Repair:

1. Make sure the correct batteries are installed.
2. Make sure the correct battery charger is installed.
3. If the previous steps do not resolve the problem, contact your Cummins service representative.

Code 488 - Intake Manifold Temperature High (Warning)

Logic: Engine intake manifold temperature has exceeded 85 °C (185 °F) for more than 90 seconds.

Possible Causes:

1. High ambient temperature
2. Blocked radiator
3. Closed or damaged louvers
4. Damaged or obstructed charge air cooler fins or radiator fins
5. Broken or loose fan belt
6. Malfunctioning fan drive or fan controls

-
7. Inaccurate coolant temperature sensor
 8. Fault simulation feature enabled
 9. Incorrect threshold setting

Diagnosis and Repair:

1. High ambient temperature
 - a. Use a thermocouple to verify air temperature entering the intake louver of the generator set.
 - b. Reduce loads or recirculation of discharge air to the generator set in elevated ambient temperatures.
2. Blocked radiator
 - a. Inspect the radiator for debris or blockages.
 - b. Remove the blockage or winterfront if necessary.
3. Closed or damaged louvers
 - a. Inspect the louvers for proper operation.
 - b. Repair and/or replace any that are damaged.
 - c. Check the louver motor for proper operation.
 - d. If the louver motor is operational, verify the louver shutter thermostat is operational.
4. Damaged or obstructed charge air cooler fins or radiator fins
 - a. Inspect for dirt, debris or obstructions.
 - b. Clean and/or remove if necessary.
5. Broken or loose fan belt
 - a. Inspect belt(s) for damage, wear, and proper tension.
 - b. Repair and/or replace belts if necessary.
6. Malfunctioning fan drive or fan controls
 - a. Inspect the pulleys and belt tensioner for damage or wear.
 - b. Repair and/or replace faulty components if necessary.
7. Inaccurate coolant temperature sensor
 - a. Use a thermocouple or similar device to measure the coolant temperature near the sender. Compare that temperature to the coolant temperature displayed.
 - b. Measure the temperature sender resistance. Compare that to the specifications in the engine manual.
 - c. Verify continuity from the temperature sender wire to the engine ECM. Harness resistance should be less than 5 Ohms.
 - d. Repair and/or replace faulty components or wiring if necessary.

8. Fault simulation feature enabled
 - a. Use the service tool to connect to the engine ECM. Verify the fault override toggle is disabled.
 - b. Reconfigure the generator set and disable fault overrides if necessary.
9. Incorrect threshold setting
 - a. Use the service tool to connect to the engine ECM and verify fault threshold settings. Compare those to the specifications in the engine manual.
 - b. Verify the ECM and PCC calibration number and revision are correct.
 - c. Recalibrate the engine ECM to reset the threshold settings.

Code 1433 or 1434 - Emergency Stop

The local **Emergency Stop** button is situated on the front of the operator panel. This is a mechanically latched switch that will unconditionally stop the engine when pressed, bypassing any time delay to stop. Push this button for emergency shutdown of the engine.

NOTICE

If the engine is not running, pushing the button will prevent the starting of the engine, regardless of the start signal source (Manual or Auto - Remote).

When the **Stop** button is pressed, the display will indicate the shutdown condition by illuminating the red **Shutdown** status LED  and displaying the following message on the graphical LCD display:

- Fault Number: 1433 LOCAL EMERGENCY STOP

A remote **Emergency Stop** button may be incorporated within the installation. If this remote **Emergency Stop** button is activated, the following message will be displayed:

- Fault Number: 1434 REMOTE EMERGENCY STOP

To reset:

1. Pull, or twist and pull the button out.
2. Press the **Stop** button on the operator panel to acknowledge this action.
3. Press the **Reset** button.
4. Press the **Auto** or **Manual Run** button, as previously determined. See the Selecting Operating Modes section.

NOTICE

Do not use an Emergency Stop button to shut down an engine unless a serious fault develops. The Emergency Stop button must not be used for a normal shut-down because this will prevent a cooling down run in which the lubricating oil and engine coolant safely carry away heat from the engine combustion chamber and bearings.

NOTICE

Make sure that the cause of the Emergency Stop is fully investigated and remedied before a fault Reset and generator set Start are attempted.

NOTICE

An Emergency Stop button is situated in close proximity to the operator panel viewing window.

Code 1435 - Low Coolant Temperature

Logic: Engine coolant temperature is below the low coolant temperature warning threshold.

Possible Causes:

1. Ambient temperature too cold for specified generator set
2. Coolant heater malfunction or not installed
3. Blockage in coolant system

Diagnosis and Repair:

1. Make sure the generator set meets its performance specifications.
2. Make sure the coolant heater is installed and powered.
3. If the previous steps do not resolve the problem, contact your Cummins service representative.

6.5 Line Circuit Breaker

A line circuit breaker is mounted in the generator output box. If the load exceeds the circuit breaker current rating, the line circuit breaker will open, preventing the generator set from being overloaded. If the circuit breaker trips, locate the source of the overload or short circuit, and correct/eliminate the fault. Manually reset the breaker. Clear any fault messages and when safe to do so, reconnect the load to the generator.

Line Circuit Breaker Location

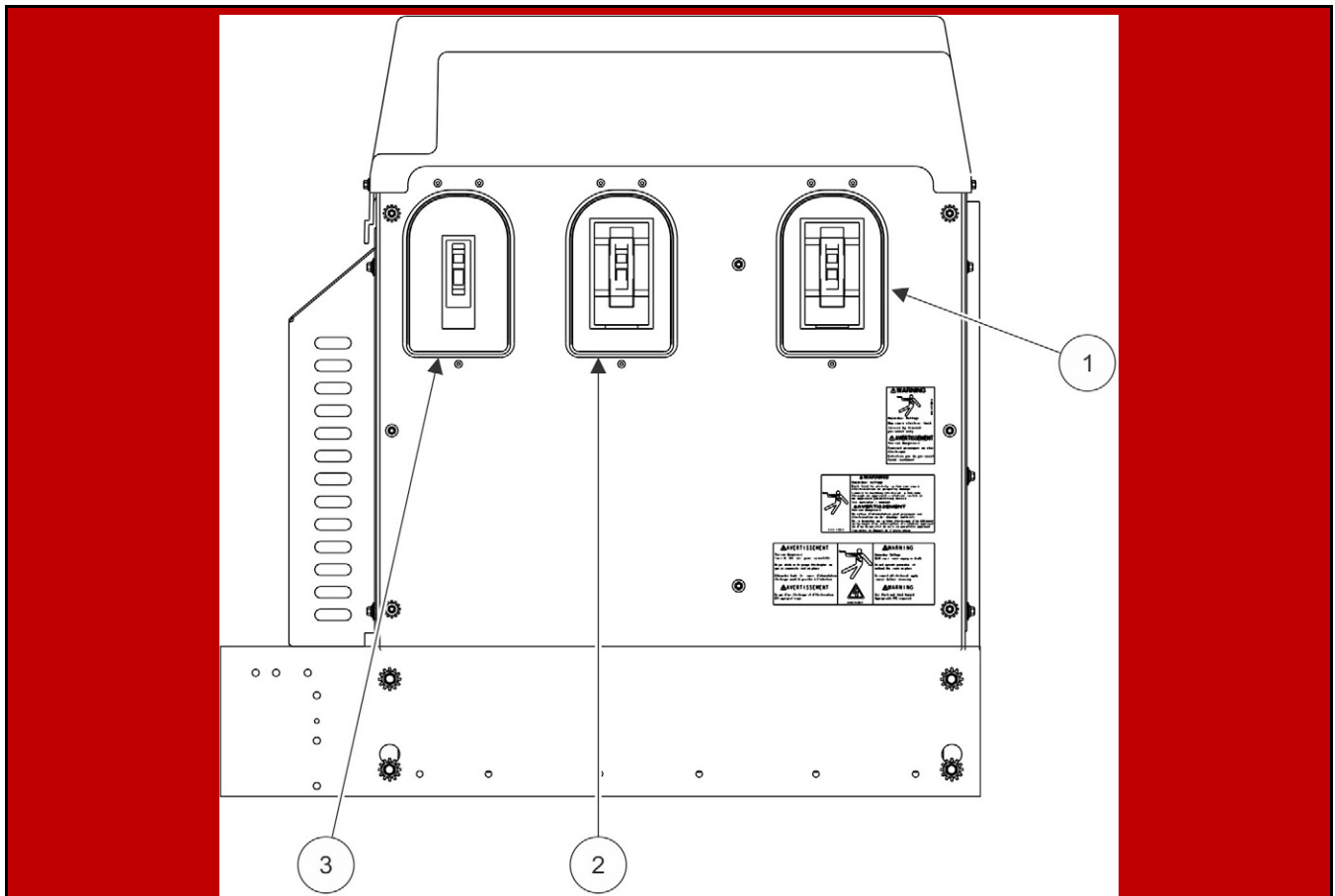

No.	Description	No.	Description
1	Circuit Breaker - Position A (Standard)	3	Circuit Breaker - Position C (Optional)
2	Circuit Breaker - Position B (Optional)		

FIGURE 26. LINE CIRCUIT BREAKER LOCATION

This page is intentionally blank.

power.cummins.com

Copyright © 2019 Cummins Inc. All rights reserved.

Cummins, the "C" logo, PowerCommand, AmpSentry, and InPower are trademarks of Cummins Inc.

Other company, product, or service names may be trademarks or service marks of others.

Specifications are subject to change without notice.

